

Network Working Group
Request for Comments: 1221
Updates: RFC 907

W. Edmond
BBN
April 1991

Host Access Protocol (HAP) Specification - Version 2

Status of this Memo

This memo describes the Host Access Protocol implemented in the Terrestrial Wideband Network (TWBNET). It obsoletes most but not all of RFC 907. This memo provides information for the Internet community. It does not specify an Internet standard. Distribution of this memo is unlimited.

Preface

This memo specifies the Host Access Protocol (HAP). HAP is a Network layer (OSI Layer 3 lower) access protocol that was first implemented about a decade ago for the DARPA/DCA sponsored Wideband Packet Satellite Network (WBNET), the precursor of the current Terrestrial Wideband Network (TWBNET). This version of the specification obsoletes references [1] and [2] in addition to most of RFC 907.

HAP is a developmental protocol, and will be revised as new capabilities are added and unused features are eliminated or revised. One reason that HAP is being revised now is that, unlike the original WBNET's satellite channel, the TWBNET's T1 fiber links are not a broadcast medium. This has prompted some changes to the protocol that will permit greater efficiency in a mesh topology network. Another cause of revision is the need to make HAP able to support a variety of OSI layer 3 upper protocols, such as DECNET Phase V, ST, and CLNP, where before only Internet Protocol (IP) was used. Appendix B describes how backward compatibility with the older IP-only version of HAP is achieved. A third cause of protocol changes is the desire to simplify interaction between ST2 protocol (RFC 1190) agents and the TWBNET. This has mainly affected the way certain setup errors are handled. These changes are expected to be backward compatible. Appendix A describes two capabilities that may be added to HAP in the future.

One of the protocol enhancements, "Group Streams", described in reference [2] has been eliminated. There are no known applications that use the feature. As described in Appendix A, a new mechanism, to be called "shared streams", capable of providing equivalent capabilities will be implemented if needed. Changes in [2] that have been retained include various query/reply control messages that permit a host to determine what resources it owns (mostly useful for

cleanup following a host reboot or crash).

This document assumes the reader is familiar with DoD internetworking terminology.

1. Introduction

The Host Access Protocol (HAP) is a network layer protocol (as is X.25). ("Network layer" here means ISO layer 3 lower, the protocol layer below the DoD Internet Protocol (IP) layer [3] and above any link layer protocol.) HAP defines the different types of host-to-network control messages and host-to-host data messages that may be exchanged over the access link connecting a host and the network packet switch node. The protocol establishes formats for these messages, and describes procedures for determining when each type of message should be transmitted and what it means when one is received.

HAP has been implemented in the wide-area network called the Terrestrial Wideband Network (TWBNET) [5] and in the routers and other hosts that connect to TWBNET. The packet switch nodes that compose the TWBNET are called Wideband Packet Switches (WPS).

Both the precursor to HAP, the Host/SATNET Protocol [6], used in the Atlantic Packet Satellite Network (SATNET) and the Mobile Access Terminal Network (MATNET [7]), and HAP, used in the original Wideband Satellite Network (WBNET) [8], were originally designed to provide efficient access to the single satellite channel each network used to connect all sites. The HAP protocol designers reflected some of the peculiarities of the single satellite channel environment in the HAP protocol itself. The current Terrestrial Wideband Network (TWBNET) utilizes T1-speed fiber connections between sites. Future networks and TWBNET may use a combination of terrestrial connections and satellite connections, and may have more than one of each. The HAP protocol has been changed to accommodate these extensions.

Section 2 presents an overview of HAP. Details of HAP formats and message exchange procedures are contained in Sections 3 through 10. Further explanation of some of the topics addressed in this HAP specification can be found in reference [1].

Any protocol employed to provide sufficiently reliable message exchange over the Host-WPS link is assumed to be transparent to the protocol defined in this document. Examples of such link-level protocols are ARPANET 1822 local and distant host [9], ARPANET VDH protocol [9], and HDLC.

2. Overview

HAP can be characterized as a full duplex, nonreliable protocol with an optional flow control mechanism. HAP messages flow simultaneously in both directions between the WPS and the host. Transmission is nonreliable in the sense that the protocol does not provide any guarantee of error-free sequenced delivery. If error-free delivery on the host's access link is required, it must be provided by the link layer protocol below HAP. (Use of link layer protocols for this purpose is not within the scope of this document.) HAP's flow control mechanism operates independently in each direction, but the choice to enable flow control or not applies to both directions together.

HAP supports host-to-host communication in two modes corresponding to the two types of HAP data messages, datagram messages and stream messages. Each type of message can be up to 2048 octets in length. The basic transmission service in the network is datagram service. Datagrams are variable length, unsequenced, independent, and delivery is not guaranteed. The HAP header of each datagram determines the processing of the message.

On this datagram service base a "stream" service is built. Stream service provides network bandwidth guarantees, but requires explicit setup and teardown operations to allocate and deallocate network resources. Stream traffic is best suited for continuous media traffic, but may also be used to obtain the lowest possible network delay. Host streams are established by a setup message exchange between the host and the network prior to the commencement of data flow. Although established host streams can have their characteristics modified by subsequent setup messages while they are in use, the fixed allocation properties of streams relative to datagrams impose rather strict requirements on the source of the traffic using the stream. Stream traffic arrivals must match the stream allocation both in interarrival time and message size if reasonable efficiency is to be achieved. The characteristics and use of datagrams and streams are described in detail in Sections 3 and 4 of this document.

Both datagram and stream transmission in the network use logical addressing. Each host on the network is assigned a permanent 16-bit logical address which is independent of the physical port on the WPS to which it is attached. These 16-bit logical addresses are present in all Host-to-WPS and WPS-to-Host data messages.

HAP supports multicast addressing via "groups". Multicast addressing is provided primarily to support the multi-destination delivery required for conferencing applications. Group addresses are

dynamically created and deleted by the use of setup messages exchanged between a host and the WPS. Membership in a group may be any arbitrary subset of the network hosts. A message addressed to a group address is delivered to all hosts that are members of that group, except the sender. Once a multicast address has been created, any member host may use that address, not just the creator.

Although HAP does not guarantee error-free delivery, error control is an important aspect of the protocol design. HAP error control is concerned with both local transfers between a host and its local WPS and transfers through the network to the destination(s). The WPS offers users a choice of network error protection options based on the network's ability to selectively send messages over its transmission media at different forward error correction (FEC) rates. These FEC options are referred to as reliability levels. Four reliability levels (low, medium-low, medium-high, and high) are available. The precise error rate provided by each reliability level is not specified.

Various checksum and CRC mechanisms are employed in the network to provide an error detection capability. A host has an opportunity when sending a message to indicate whether the message should be delivered to its destination or discarded if a data error is detected by the network. Each message received by a host from the network will have a flag indicating whether or not an error was detected in that particular message. A host can decide on a per-message basis whether or not it wants to accept or discard transmissions containing data errors.

For connection of a host and WPS in close proximity, error rates due to external noise or hardware failures on the access circuit may reasonably be expected to be much smaller than the best network trunk circuit error rates. Thus for this case, little is gained by using error detection and retransmission on the access circuit. A 16-bit header checksum is provided, however, to ensure that WPSen do not act on incorrect control information. For relatively long distances or noisy connections, retransmissions over the access circuit may be required to optimize performance for both low and high reliability traffic. It is expected that link layer error control procedures (such as HDLC with retransmission) will be used for this purpose, but use of a reliable link layer protocol is not within the scope of this document.

Each datagram message submitted to the WPS by a host is marked as being in one of three priority classes, from priority 2 (highest) through priority 0 (lowest). The priority class is used by the WPS for arbitrating contention for scarce network resources (e.g., link bandwidth). That is, if the network cannot deliver all of the

offered messages, high priority messages will be delivered in preference to low priority messages. Priority level affects the order of access to intersite link bandwidth and the order of message delivery at the destination WPS.

Each stream message also has three priority classes, from priority 2 (highest) through priority 0 (lowest). In addition, streams themselves have three precedence classes, from precedence 2 (highest) through precedence 0. A stream of higher precedence can preempt a stream of lower precedence at setup time. Stream message priority provides a mechanism for a low-bandwidth host to receive a high-bandwidth stream and selectively discard messages marked as less important by the sender. Stream message priority does not affect the order of delivery of stream messages between the source and the destination.

Datagram and stream messages being presented to the WPS by a host may not be accepted for a number of reasons: priority too low, destination dead, lack of buffers in the source WPS, etc. The host faces a similar situation with respect to handling messages from the WPS. To permit the receiver of a message to inform the sender of the local disposition of its message, an acceptance/refusal (A/R) mechanism is implemented. The mechanism is the external manifestation of the WPS's (or host's) internal flow and congestion control algorithm. If A/Rs are enabled, an explicit or implicit acceptance or refusal for each message is returned to the host by the WPS (and conversely). This allows the host (or WPS) to retry refused messages at its discretion and can provide information useful for optimizing the sending of subsequent messages when the reason for refusals is also provided. The A/R mechanism can be disabled to provide a "pure discard" interface. The host's choice to use the A/R mechanism or not does not limit its ability to send and receive messages to any other hosts.

While the A/R mechanism allows control of individual message transfers, it does not facilitate regulation of priority flows. Such regulation is handled by passing advisory status information (GOPRI) across the Host-WPS interface indicating which priorities are currently being accepted. As long as this information, relative to the change in priority status, is passed frequently, the sender can avoid originating messages which are sure to be refused.

HAP defines both data messages (datagram messages and stream messages) and link control messages. Data messages are used to send information between hosts on the network. Link control messages are exchanged between a host and the WPS to manage the local access link.

Allocation of network resources, such as streams and groups, is

accomplished via an exchange of datagram messages, called Setups, between the user host and an agent inside the WPS called the "Service Agent." Setups are used to reserve, allocate, modify, free, and deallocate network resources. Each allocated resource has a unique identifier which, when placed in an appropriate field in a message header, allows that message to use the resource. E.g., after an exchange of Setups to create a group address, a message may be sent to the group by placing the group address in the destination field of that message. The Service Agent also permits a host to inquire about resources it owns.

Every HAP message consists of an integral number of 16-bit words (i.e., an even number of octets). The first several words of the message always contain control information and are referred to as the message header. The first word of the message header identifies the type of message which follows. The second word of the message header is a checksum which covers all header information. Any message whose received header checksum does not match the checksum computed on the received header information must be discarded. The format of the rest of the header depends on the specific message type.

The formats and use of the individual message types are detailed in the following sections. A common format description is used for this purpose. Words in a message are numbered starting at zero (i.e., zero is the first word of a message header). Bits within a word are numbered from zero (most significant) to fifteen (least significant). The notation used to identify a particular field location is:

```
<WORD#>{-<WORD#>} [ <BIT#>{-<BIT#>} ] <description>
```

where optional elements in {} are used to specify the (inclusive) upper limit of a range. The reader should refer to these field identifiers for precise field size specifications. Fields which are common to several message types are defined in the first section which uses them. Only the name of the field will usually appear in the descriptions in subsequent sections.

Link-level protocols used to support HAP can differ in the order in which they transmit the bits constituting HAP messages. The words of the message are transmitted from word 0 to word N.

3. Datagram Messages

Datagrams are one of the two message types provided by HAP, as described in the previous section. Because network resources are not reserved in advance for datagram traffic, delivery of datagram traffic is subject to greater delivery delays and delay variance than stream traffic, and is subject to flow and congestion controls.

Datagram priority determines which packets are delivered or discarded when network resources do not permit handling all of the presented traffic. It is expected that datagram messages will be used to support the majority of computer-to-computer and terminal-to-computer traffic which is bursty in nature.

The format of datagram messages and the purpose of each of the header control fields is described in Figure 1.

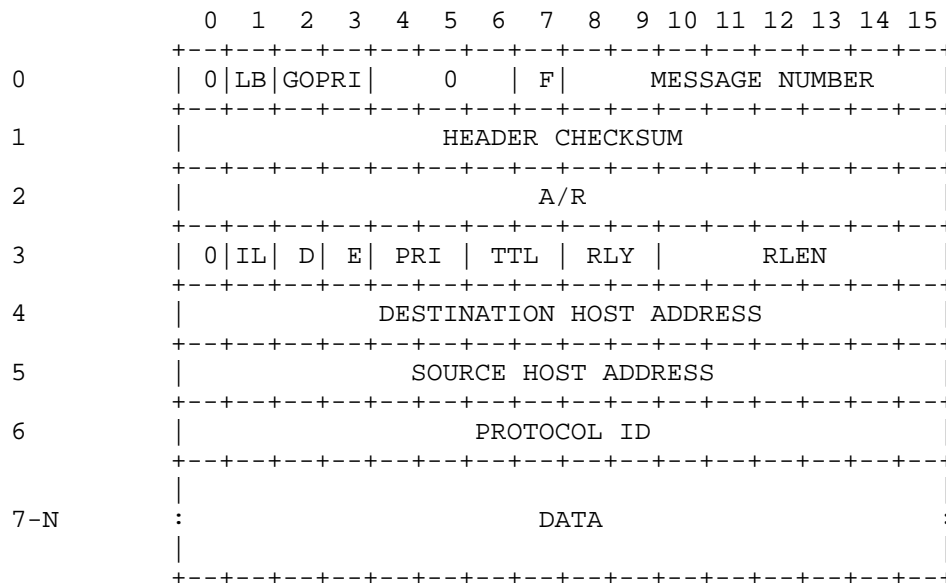

DATAGRAM MESSAGE

Figure 1

0[0] Message Class. This bit identifies the message as a data message or a control message.

0 = Data Message
1 = Control Message

0[1] Loopback indicator. This bit allows the sender of a message to determine if its own messages are being looped back. The host and the WPS each use different settings of this bit for their transmissions. If a message arrives with the loopback bit set equal to its

outgoing value, then the message has been looped.

0 = Sent by Host
1 = Sent by WPS

0[2-3] Go-Priority. In WPS-to-Host messages, this field provides advisory information concerning the lowest priority currently being accepted by the WPS. The host may optionally choose to provide similar priority information to the WPS.

0 = Low Priority
1 = Medium Priority
2 = High Priority
3 = (Reserved.)

0[4-6] Reserved. Must be zero.

0[7] Reserved. Must be zero. Formerly used for WPS diagnostic purposes.

0[8-15] Message Number. This field contains the identification of the message used by the acceptance/refusal (A/R) mechanism (when enabled). If the message number is zero, A/R is disabled for this specific message. See Section 5 for a detailed description of the A/R mechanism.

1[0-15] Header Checksum. The checksum is the 2's-complement of the 2's-complement sum of words 0-6 (excluding the checksum word itself).

2[0-15] Piggybacked A/R. This field may contain an acceptance/refusal word providing A/R status on traffic flowing in the opposite direction. Its inclusion may eliminate the need for a separate A/R control message (see Section 5). A value of zero for this word is used to indicate that no piggybacked A/R information is present.

3[0] Data Message Type. This bit identifies whether the message is a datagram message or a stream message.

0 = Datagram Message
1 = Stream Message

3[1] IL flag. Obsolete. Must be zero. (See Appendix B.)

3[2] Discard Flag. This flag allows a source host to instruct the network (including the destination host) what to do with the message when data errors are detected (assuming the header checksum is correct).

- 0 = Discard message if data errors detected.
- 1 = Don't discard message if data errors detected.

The value of this flag, set by the source host, is passed on to the destination host.

3[3] Data Error Flag. This flag is used in conjunction with the Discard Flag to indicate to the destination host whether any data errors have been detected in the message prior to transmission over the destination's WPS-to-Host access link. It is used only if Discard Flag = 1. It should be set to zero by the source host.

- 0 = No Data Errors Detected
- 1 = Data Errors Detected

3[4-5] Priority. The source host uses this field to specify the priority with which the message should be handled within the network.

- 0 = Low Priority
- 1 = Medium Priority
- 2 = High Priority
- 3 = (Reserved.)

The priority of each message is passed to the destination host by the destination WPS.

3[6-7] Time-to-Live Designator. The source host uses this field to specify the maximum time that a message should be allowed to exist within the network before being deleted. Elapsed time begins when the message has been received by the WPS from the source host (or is sent by a WPS agent) and is last checked when the message is queued for transmission out the I/O interface to the destination host. If a message is multicast, each copy is treated separately.

- 0 = 1 seconds
- 1 = 2 seconds
- 2 = 5 seconds
- 3 = 10 seconds

- 3[8-9] Reliability. The source host uses this field to specify the basic bit error rate requirement for the data portion of this message. The source WPS uses this field to determine the trunk circuit transmission parameters and forward error correction level required to provide that bit error rate.
- 0 = Low Reliability
 - 1 = Medium-Low Reliability
 - 2 = Medium-High Reliability
 - 3 = High Reliability
- 3[10-15] Reliability Length. The source host uses this field to specify a portion of the user data which should be transmitted at the highest reliability level (lowest bit error rate). Both the HAP message header words and the first 2*<Reliability Length> octets of user data will be transmitted at high reliability while the remainder of the user data will be transmitted at whatever reliability level is specified in field 3[8-9]. The reliability length mechanism gives the user the ability to transmit private header information (e.g., IP and TCP headers) at a higher reliability level than the remainder of the data.
- 4[0-15] Destination Host Address. This field contains the network logical address of the destination host.
- 5[0-15] Source Host Address. This field contains the network logical address of the source host.
- 6[0-15] Protocol ID. This field specifies the next higher level protocol. Protocol identifiers are assigned administratively, except 0 which is reserved, and are not part of this specification. See reference [10].
- 7-N Data. This field contains up to 16,384 bits (2048 octets) of user data, and must be an even number of octets.

4. Stream Messages

Stream messages are the second message type provided by HAP, as described in Section 2. Streams provide guaranteed bandwidth between the source and destination(s), and provide the minimum delivery delay and delay variance available in the network. Streams are suitable for volatile traffic, such as speech, and for support of high duty cycle applications that require throughput guarantees.

Streams must be created before stream messages can flow from host to host. The protocol to accomplish stream creation is described in Section 6.1. Once established, a stream is allocated specific network resources, such as bandwidth. Within the bounds of its stream allocation, a host is permitted considerable flexibility in how it may use the stream. Although the time to live, reliability, and reliability length of each stream message is fixed at stream setup time, the destination logical address can vary from stream message to stream message.

A host can, therefore, multiplex a variety of logical flows onto a single stream, as long as the stream was set up to reach all the destination hosts. The format of stream messages is described in Figure 2.

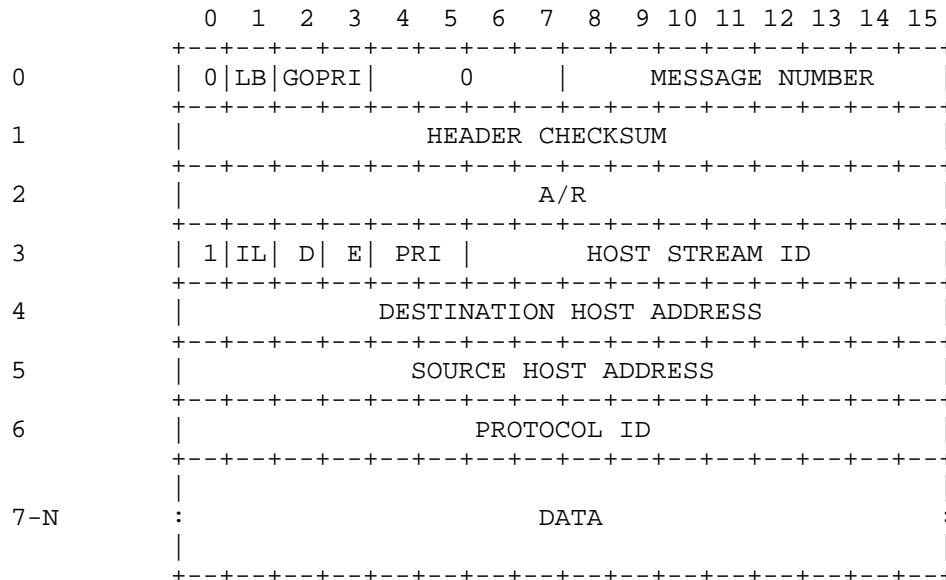

STREAM MESSAGE
Figure 2

- 0[0] Message Class = 0 (Data Message).
- 0[1] Loopback indicator.
- 0[2-3] Go-Priority.

- 0[4-7] Reserved.
- 0[8-15] Message Number. This field serves the same purpose as the message number field in the datagram message. Moreover, a single message number sequence is used for both datagram and stream messages (see Section 5).
- 1[0-15] Header Checksum. (See datagram checksum for description.)
- 2[0-15] Piggybacked A/R.
- 3[0] Data Message Type = 1 (Stream).
- 3[1] IL flag. Obsolete. Must be zero.
- 3[2] Discard Flag.
- 3[3] Data Error Flag.
- 3[4-5] Stream message priority. Note that all stream messages have priority over any datagram message. Priority will not affect the order of stream message delivery.
- 0 = Low priority
 - 1 = Medium priority
 - 2 = High priority
 - 3 = Reserved
- 3[6-15] Stream ID. The WPS uses this field to identify the preallocated network resources (bandwidth allocations, queues, buffers, etc.) to use for delivery of the message. Streams and their identifying numbers (stream IDs) are established by an explicit Create Stream request (see Section 6.1).
- 4[0-15] Destination Host Address.
- 5[0-15] Source Host Address.
- 6[0-15] Protocol ID.
- 7-N Data. This field contains up to 16,384 bits (2048 octets) of user data, and must be an even number of octets.

5. Flow Control Messages

The WPS supports an acceptance/refusal (A/R) mechanism in each direction on the host access link. The A/R mechanism is enabled for the link by the host by setting a bit in the Restart Complete control message (see Section 8). Each datagram and stream message contains an 8-bit message number used to identify the message for flow control purposes. When the A/R mechanism is enabled, the message number is incremented modulo 256 in successive messages, skipping over message number zero (zero indicates that A/R's are disabled for that message). Up to 127 messages may be outstanding (awaiting acceptance or refusal) in each direction. If the receiver of a message is unable to accept the message, a refusal indication containing the message number of the refused message and the reason for the refusal is returned. The refusal indication may be piggybacked on data messages in the opposite direction over the link or may be sent in a separate control message in the absence of reverse data traffic.

Acceptance indications are returned in a similar manner, either piggybacked on data messages or in a separate control message. An acceptance is returned by the receiver to indicate that the identified message was received from the host access link and was not refused. Acceptance indications returned by the WPS are not an end-to-end acknowledgement and do not imply any guarantee of delivery to the destination host(s), or even any assurance that the message will not be intentionally discarded by the network. They are sent primarily to facilitate buffer management in the host.

To reduce the number of A/R messages exchanged, a single A/R indication can be returned for multiple (lower numbered) previously unacknowledged messages. Explicit acceptance of message number N implies implicit acceptance of outstanding messages with numbers N-1, N-2, etc., according to the definition of acceptance outlined above. Analogous interpretation of the refusal message number allows the receiver of a group of messages to reject them as a group when they all are being refused for the same reason. As a further efficiency measure, HAP permits aggregation of any mix of A/R indications into a single A/R control message. Such a message might be used, for example, to reject a group of messages where the refusal code on each is different.

In some circumstances the overhead associated with processing A/R messages may prove unattractive. For these cases, it is possible to disable the A/R mechanism and operate the HAP interface in a purely discard mode. The ability to effect this on a link basis has already been noted (see Sections 2 and 8). In addition, messages with sequence number zero are taken as messages for which the A/R mechanism is selectively disabled. To permit critical feedback, even

when operating in discard mode, HAP defines an "Unnumbered Response" control message. Flow control information, and other information which cannot be sent as an A/R indication, is sent in an Unnumbered Response control message. The format of this type of message is illustrated in Figure 5.

The format shown in Figure 3 is used both for A/R indications that are piggybacked on data messages (word 2), and for aggregated A/R information in A/R control messages. The format of A/R control messages is shown in Figure 4.

```

      0  1  2  3  4  5  6  7  8  9 10 11 12 13 14 15
+---+---+---+---+---+---+---+---+---+---+---+---+---+---+---+
|AR|   REFUSAL CODE   | A/R MESSAGE NUMBER |
+---+---+---+---+---+---+---+---+---+---+---+---+---+---+---+

```

ACCEPTANCE/REFUSAL WORD
Figure 3

[0] Acceptance/Refusal Type. This field identifies whether A/R information is an acceptance or a refusal.

0 = Acceptance
1 = Refusal

[1-7] Refusal Code. When the Acceptance/Refusal Type = 1, this field gives the Refusal Code.

0 = Priority not being accepted
1 = Source WPS congestion
2 = Destination WPS congestion
3 = Destination host dead
4 = Destination WPS dead
5 = Illegal destination host address
6 = Destination host access not allowed
7 = Illegal source host address
8 = Message lost in access link
9 = Invalid stream ID
10 = Illegal source host for stream ID
11 = Message length too long
12 = Stream message too early
13 = Illegal control message type
14 = Illegal refusal code in A/R
15 = Can't implement loop

- 16 = Destination host congestion
- 17 = Delivery refused
- 18 = Odd byte length packet (not allowed)
- 19 = Invalid stream time-to-live value
- 20 = "Reliability length" exceeds message length

[8-15] A/R Message Number. This field contains the number of the message to which this acceptance/refusal refers. It also applies to all outstanding messages with earlier numbers. Note that this field can never be zero since a message number of zero implies that the A/R mechanism is disabled.

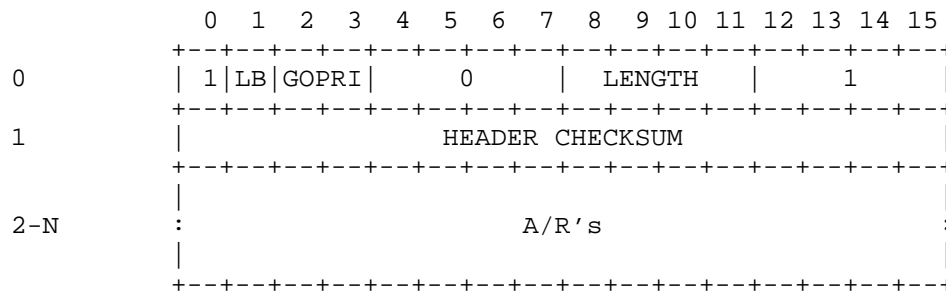

ACCEPTANCE/REFUSAL MESSAGE
Figure 4

- 0[0] Message Class = 1 (Control Message).
- 0[1] Loopback indicator.
- 0[2-3] Go-Priority.
- 0[4-7] Reserved.
- 0[8-11] Message Length. This field contains the total length of this message in words (N+1).
- 0[12-15] Control Message Type = 1 (Acceptance/Refusal).
- 1[0-15] Header Checksum. The checksum is the 2's-complement of the 2's-complement sum of words 0-N (excluding the checksum word itself).

- 2[0-15] Acceptance/Refusal Word.
 3-N Additional Acceptance/Refusal Words (optional).

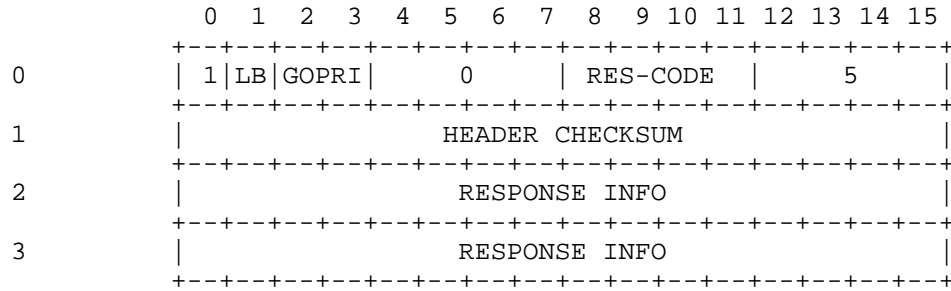

UNNUMBERED RESPONSE
 Figure 5

- 0[0] Message Class = 1 (Control Message).
 0[1] Loopback indicator.
 0[2-3] Go-Priority.
 0[4-7] Reserved.
 0[8-11] Response Code.
- 3 = Destination unreachable
 - 5 = Illegal destination host address
 - 7 = Illegal source host address
 - 9 = Nonexistent stream ID
 - 10 = Illegal stream ID
 - 13 = Protocol violation
 - 15 = Can't implement loop
- 0[12-15] Control Message Type = 5 (Unnumbered Response).
 1[0-15] Header Checksum. The checksum is the 2's-complement of the 2's-complement sum of words 0-3 (excluding the checksum word itself).
 2[0-15] Response Information. If Response Code is:

3: Destination Host Address
5: Destination Host Address
7: Source Host Address
9: Stream ID (right justified)
10: Stream ID (right justified)
13: Word 0 of offending message
15: Word 0 of Loopback Request message

3[0-15] Response Information. If Response Code is:

3,5,7, or 9: Undefined
10: Source Host Address
13: Word 3 of offending message, or 0 if no word 3
15: Word 2 of Loopback Request message

6. The Service Agent

Allocation of network resources, such as streams and groups, is accomplished via an exchange of datagram messages, called Setup messages, between the user host and the Service Agent (network address zero). Setup operations include reserving, allocating, modifying, freeing, and deallocating resources. The Service Agent causes the requested action to be carried out and serves as the intermediary between the user and the rest of the network. In the process of implementing the requested action, various network data bases are updated to reflect the current state of the referenced resource. The Service Agent also permits a host to inquire about resources it owns using Information Request and Information Reply messages.

A setup interaction initiated by a host involves a 3-way exchange where: (1) the requesting host sends a Setup Request to the Service Agent, (2) the Service Agent returns a Setup Reply to the requesting host, and (3) the requesting host returns a Setup Acknowledgment to the Service Agent. This procedure is used to ensure reliable transmission of Setup Requests and Replies. In order to allow more than one Setup Request message from a host to be outstanding, each Request is assigned a unique Request ID. The associated Reply and subsequent Acknowledgment are identified by the Request ID that they contain. The requesting host should receive a reply to a setup request within 3 seconds. The actual delay will depend on the nature of the request and the topology of the network. For simple networks, the delay will often be less than one second. The requesting host should respond to a Reply with a Setup Acknowledgment within one second.

Setup exchanges initiated by the Service Agent involve a two-way exchange where: (1) the Service Agent sends a Notification to

affected hosts, and (2) the hosts return a Setup Acknowledgment to the Service Agent. Notifications are used to inform a host of changes in the status of a network resource. In order to allow more than one Notification to be outstanding, each is assigned a unique Notification ID. The Setup Acknowledgment returned by the notified host to the Service Agent must contain the Notification ID. The host should respond within one second.

An information query is initiated by a host and involves a two-way exchange where: (1) the host sends an Information Request message to the Service Agent, and (2) the Service Agent sends back an Information Reply. There is no acknowledgment mechanism, since this request does not change any resource allocation. Furthermore, if there is an error in the request, only one response will be sent by the WPS, and the WPS will make no effort to check for or retransmit lost responses. It is the responsibility of the host to wait a certain amount of time and then determine that an unanswered information request has been lost and to resend it. (The time necessary to answer such a request is usually much less than one second.) The WPS will return the message ID of the information request in the information reply message.

The general format of all Service Agent messages is:

```
<DATAGRAM MESSAGE HEADER>
  <SERVICE AGENT HEADER>
    <MESSAGE BODY>
```

The Protocol ID field in the datagram message header must be HAP_PROTO_SETUP (1) (see Appendix C) for messages sent to the Service Agent and will be HAP_PROTO_SETUP in messages received from the Service Agent. The Service Agent does not recognize or support use of other higher level protocols (e.g., IP), in setup messages, and will discard messages containing such headers.

Illustrations of message formats below show only the Service Agent Header header and message body and do not include the datagram message header. As a reminder that the datagram header is not included, word offsets are prefixed with an "S".

The format of the Service Agent Header is illustrated in Figure 6. The body of the message will depend on the particular message type. Stream Request and Reply messages are described in Section 6.1. Group Request and Reply messages are described in Section 6.2. The format of Notifications is described in Section 6.3, and Setup Acknowledgments are described in Section 6.4. Information Request and Reply messages are described in Section 6.5.

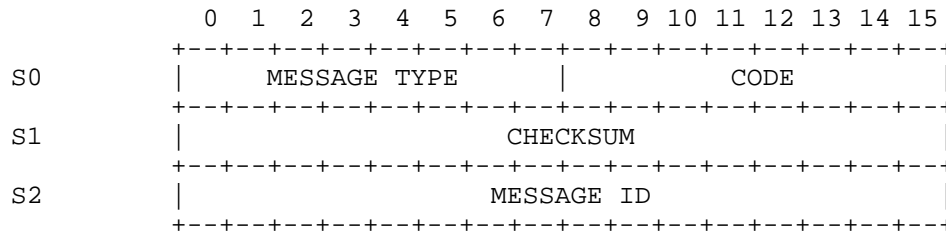

SERVICE AGENT HEADER

Figure 6

S0[0-7] Message Type. This field determines the type of message.

- 0 = Setup Acknowledgment
- 1 = Setup Request
- 2 = Setup Reply
- 3 = Notification
- 4 = Information Request
- 5 = Information Reply

S0[8-15] Code. For Setup Requests, this field identifies the request type.

- 1 = Create group (multicast) address
- 2 = Delete group address
- 3 = Join group
- 4 = Leave group
- 5 = Create stream
- 6 = Delete stream
- 7 = Change stream
- 8 = Create shared stream
- 9 = Delete all streams owned by this host
- 10 = Add member to group
- 11 = Remove member from group

For Setup Replies, this field provides the Reply Code. Some of the Reply Codes can be returned to any setup request and others are request specific.

- 0 = Group or stream created
- 1 = Group or stream deleted
- 2 = Host added to group
- 3 = Host deleted from group
- 4 = Stream changed

- 5 = (Reserved)
- 6 = Request type invalid or unsupported
- 7 = (Reserved)
- 8 = Network trouble
- 9 = Bad group key
- 10 = Group address/stream ID nonexistent
- 11 = Not member of group/not creator of stream
- 12 = Stream precedence not being accepted
- 13 = (Reserved)
- 14 = (Reserved)
- 15 = (Reserved)
- 16 = Unable to add all the new hosts
- 17 = Insufficient network resources
- 18 = Requested bandwidth too large
- 19 = (Reserved)
- 20 = (Reserved)
- 21 = Maximum messages per interval too small
- 22 = Reply lost in network
- 23 = Illegal priority or precedence value
- 24 = Invalid address provided

For Notifications, this field contains the Notification Type. (See Section 6.3.)

For Setup Acknowledgments, this field contains the Acknowledgment Type. (See Section 6.4.)

For Information Requests, this field contains the request type. (See Section 6.5.)

For Information Replies, this field contains the reply type. (See Section 6.5.)

S1[0-15] Checksum. The checksum is the 2's-complement of the 2's-complement sum of the words in the Service Agent Header (excluding the checksum word itself) and the message body. Messages received with bad checksums must be discarded.

S2[0-15] Message ID. This field is assigned by the host to uniquely identify outstanding requests (Request ID) and by the Service Agent to uniquely identify outstanding notifications (Notification ID).

6.1. Stream Setup Messages

Streams provide a means of reserving network resources for the delivery of traffic at a specified maximum throughput to a specified

list of recipients. Traffic sent via a stream has priority over all non-stream traffic, and is delivered with the minimum end-to-end delay possible. Hosts use streams to support applications that have predictable traffic loads (such as packet voice or video or other continuous media traffic) or that require minimum transmission delay and lowest delay variance. Streams are typically used for traffic flows of moderate to long duration, where the cost of performing a stream Setup is acceptable.

Streams must be set up before stream data messages can flow. The stream setup messages, each of which has a Request and a Reply, are Create Stream, Delete Stream, Change Stream, and Delete All Streams. (Create Shared Stream Request is a planned future addition to the protocol.) The use of these messages is illustrated in the scenario of exchanges between a host and the Service Agent shown in Figure 7 where the host establishes a stream, sends some data, modifies the stream characteristics, sends some more data, and finally closes down the stream. Not illustrated, but implicit in this scenario, are the optional A/R indications associated with each of the stream Setup messages.

	Host	Service Agent	Other hosts
Create Stream Request		----->	
Create Stream Reply	<-----		
Reply Acknowledgment		----->	
Stream Messages		----->	
: :			
Change Stream Request		----->	
Change Stream Reply	<-----		
Reply Acknowledgment		----->	
Stream Messages		----->	
: :			
Delete Stream Request		----->	
Delete Stream Reply	<-----		
Reply Acknowledgment		----->	

STREAM EXAMPLE

Figure 7

Streams have eight characteristic properties which are selected at stream setup time. These properties are: (1) data words per time interval, (2) time interval, (3) reliability, (4) reliability length, (5) precedence, (6) maximum messages per interval, (7) the list of recipients, and (8) the set of other streams with which this stream shares resources. To establish a stream, the host sends the Create

Stream Request message (Figure 8) to the Service Agent. After the network has processed the Create Stream Request, the Service Agent will reply with a Create Stream Reply message (Figure 9). If the reply code in the Create Stream Reply indicates that the stream has been created successfully, the host may proceed to transmit stream data messages after sending a Reply Acknowledgment.

During the lifetime of a stream, the host which created it may decide that some of its characteristic properties should be modified. All but one of the properties can be modified using the Change Stream Request message (Figure 10). The one property that cannot be changed is whether or not the stream is willing to share its resources with other streams. After the network has processed the Change Stream Request, the Service Agent will respond by sending a Change Stream Reply (Figure 11) to the host. A host requesting a reduced channel allocation should decrease its sending rate immediately without waiting for receipt of the Change Stream Reply. A host requesting an increased allocation should not proceed to transmit according to the new set of parameters without first having received a Reply Code indicating that the requested change has taken effect.

When the host no longer needs the stream it created, it should first stop sending traffic via the stream and then send the Service Agent a Delete Stream Request message (Figure 12). After the network has processed the Delete Stream Request, the Service Agent will respond by sending a Delete Stream Reply (Figure 13) to the host.

If the host has crashed or restarted, it may no longer know what streams it owns. The host may use an Information Request (see Section 6.5) to determine what streams it owns, or the host may use a Delete All Streams Request (Figure 14) to discard whatever stream resources it may own. The format for the Delete All Streams Reply is shown in Figure 15.

Note that streams, like all other resources allocated by the Service Agent, may be reclaimed by the network if unused. Currently, if no traffic is sent to a stream in a 6 minute interval, and if the owner of the stream is down or unreachable, the stream may be deleted.

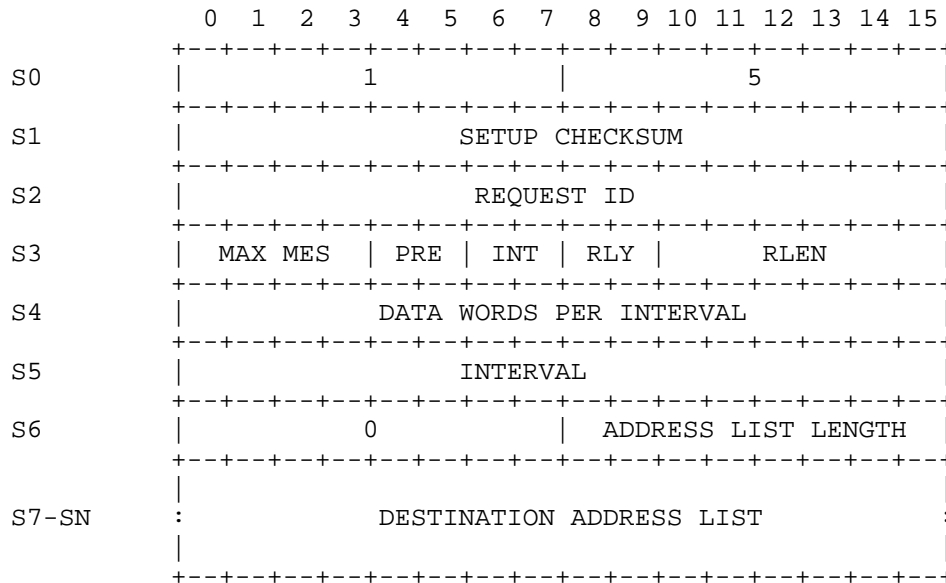

CREATE STREAM REQUEST
Figure 8

- S0[0-7] Setup Type = 1 (Request).
- S0[8-15] Request Type = 5 (Create Stream).
- S1[0-15] Setup Checksum. (See setup header description.)
- S2[0-15] Request ID.
- S3[0-3] Maximum Messages Per Interval (1-15). This field specifies the maximum number of stream messages the host will deliver to the WPS in any single stream interval.
- S3[4-5] Precedence. This field specifies the precedence of the stream. When there are insufficient network resources to support all the requested streams, requests for higher precedence streams will preempt existing lower precedence streams, and requests for streams with insufficient precedence will be rejected. Medium precedence is recommended as the default choice.

- 0 = Low Precedence
- 1 = Medium Precedence
- 2 = High Precedence

- S3[6-7] Interval. This field specifies the interval, in multiples of 21.22 milliseconds. (For backward compatibility only. New applications should use 3. Use of this field to specify an interval is being phased out.)
- 0 = 21.22 milliseconds
 - 1 = 42.44 milliseconds
 - 2 = 84.88 milliseconds
 - 3 = use interval in word S5
- S3[8-9] Reliability. This field specifies the basic bit-error rate requirement for the data portion of all messages in the stream. The exact error rate obtained by each choice is not specified.
- 0 = Low Reliability
 - 1 = Medium-Low Reliability
 - 2 = Medium-High Reliability
 - 3 = High Reliability
- S3[10-15] Reliability Length. This field specifies how many words beyond the stream message header should be transmitted at maximum reliability for all messages in the host stream.
- S4[0-15] Data words per interval. This field specifies the maximum number of 16-bit words of this stream's data the network will need to carry during each interval, not counting HAP stream message header words. The stream data may be carried in however many messages (up to MAX MES) in each interval the host chooses.
- S5[0-15] Interval (125 microsecond units). This field specifies the time interval over which the <data words per interval> data in <max mes> messages will be sent. For backward compatibility, an interval of 0 selects an interval of 169.76 milliseconds. This field is ignored unless the INT field is 3.
- S6[0-7] Reserved. Must be zero.
- S6[8-15] Destination address list length. This field specifies the number of entries in the Destination Address List

field. Allowed values are 1-8.

S7-SN Destination address list. This list must specify, at least indirectly, all the intended recipients of this stream's traffic. At least one destination address must be supplied. Any valid network address, specifically including group addresses, may be used (except the Service Agent's address, 0). Messages sent in the stream are not limited to using the HAP addresses listed. E.g., if the list consists of only group address G, and host A is a member of G, a stream message may be sent to A, which was not in the list.

Caution: Group membership is only evaluated at setup time. Changes in group membership do not cause the stream to be modified.

Caution: Stream creation involves allocation of specific network resources along specific routes for delivery of that traffic. A stream message sent to hosts other than those specified via Setup will probably be undeliverable. A stream message to a group address that has gained new members since the stream's last Setup may be undeliverable to the new members.

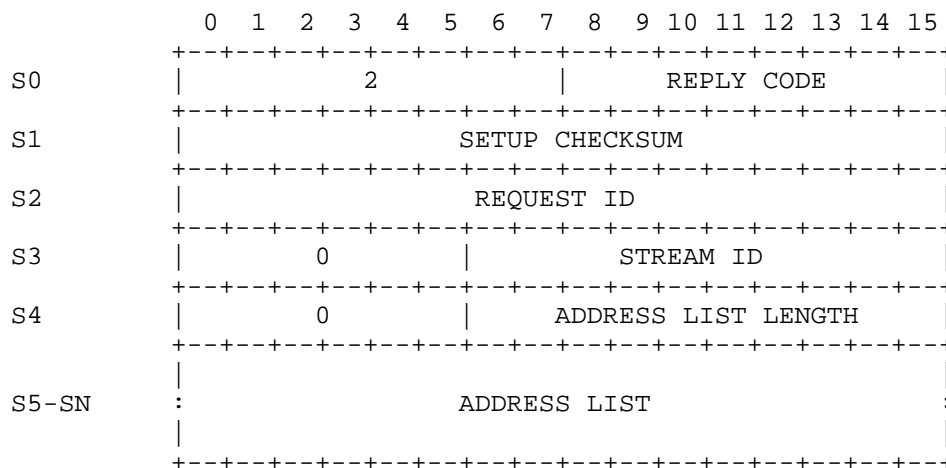

CREATE STREAM REPLY
Figure 9

S0[0-7] Setup Type = 2 (Reply).

- S0[8-15] Reply Code. Any reply other than "Stream created" means the stream was not created.
- 0 = Stream created
 - 8 = Network trouble
 - 12 = Stream precedence not being accepted
 - 17 = Insufficient network resources
 - 18 = Requested bandwidth too large
 - 21 = Max. messages per interval too small
 - 22 = Reply lost in network
 - 23 = Illegal precedence value
 - 24 = Invalid destination address in list
- S1[0-15] Setup Checksum. (See setup header description.)
- S2[0-15] Request ID.
- S3[0-5] Reserved. Must be zero.
- S3[6-15] Stream ID. This field contains a stream ID assigned by the network. It must be included in all stream data messages sent by the host to allow the WPS to associate the message with stored stream characteristics and the resources reserved for that stream's traffic.
- S4[0-5] Reserved. Must be zero.
- S4[6-15] Address list length. The number of entries in the Address List field.
- S5-SN Address list. This contains the destination addresses from the Create Stream Request that were invalid or unreachable. Unreachable destinations are listed as a group if every member of the group was unreachable, or individually otherwise; i.e., group addresses are expanded and the unreachable members are included in the list. The list of unreachable destinations will be truncated, if needed, to limit this Reply to a single, maximum length HAP message.

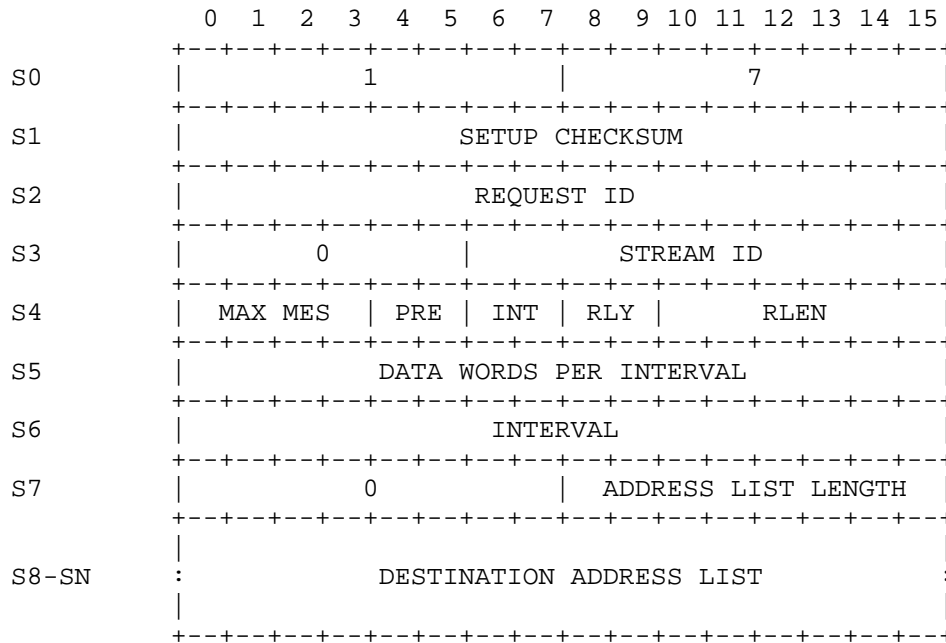

CHANGE STREAM REQUEST
Figure 10

- S0[0-7] Setup Type = 1 (Request).
- S0[8-15] Request Type = 7 (Change Stream).
- S1[0-15] Setup Checksum. (See setup header description.)
- S2[0-15] Request ID.
- S3[0-5] Reserved. Must be zero.
- S3[6-15] Stream ID.
- S4[0-3] New Maximum Messages Per Interval.
- S4[4-5] New Precedence.
- S4[6-7] New Interval selection.
- S4[8-9] New Reliability.

- S4[10-15] New Reliability Length.
- S5[0-15] New Data Words Per Interval.
- S6[0-15] New Interval (ignored unless INT = 3).
- S7[0-7] Reserved. Must be zero.
- S7[8-15] Destination Address List length. This field specifies the number of entries in the new Destination Address List. Allowed values are 0-8. Use zero (indicating no addresses in the list) to avoid changing the list of recipient hosts.
- S8-SN New Destination Address List. The new, complete, list of recipient hosts. Membership of group addresses is evaluated at setup execution time. Subsequent changes in group membership do not cause the stream to be modified. Note that using the same destination address list in the Change Stream Request as was used in the Create Stream Request can result in a change in the list of recipient hosts if membership in a group has changed.

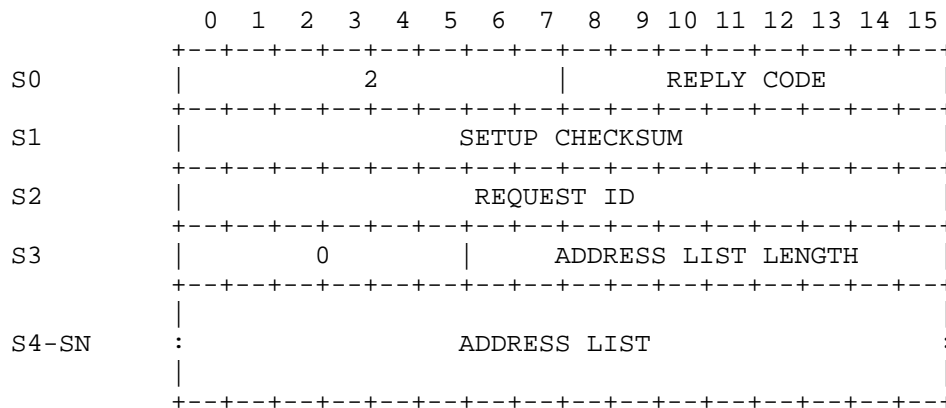

CHANGE STREAM REPLY
Figure 11

- S0[0-7] Setup Type = 2 (Reply).

S0[8-15] Reply Code. The number in parentheses indicates the processing phase at the time of the error (see Caution below). Phase zero and phase one errors leave the stream unchanged; errors from later phases may leave the stream partially modified.

- 4 = Stream changed
- 8 = (1) Network trouble
- 10 = (0) Stream ID nonexistent
- 11 = (0) Not creator of stream
- 12 = (0) Stream precedence not being accepted
- 16 = (3) Unable to add all the new recipients
- 17 = (2) Insufficient network resources
- 18 = (2) Requested bandwidth too large
- 21 = (0) Maximum messages per interval too small
- 22 = (2) Reply lost in network
- 23 = (0) Illegal precedence value
- 24 = (0) Invalid destination address in list

S1[0-15] Setup Checksum. (See setup header description.)

S2[0-15] Request ID.

S3[0-5] Reserved. Must be zero.

S3[6-15] Address list length. This field specifies the number of addresses in the Address List.

S4-SN Address list. This contains the destination addresses from the Change Stream Request that were invalid (phase 0 errors) or unreachable (phase 3 errors). Unreachable destinations are listed as a group if every member of the group was unreachable, or individually otherwise; i.e., group addresses are expanded and the unreachable members are included in the list. The list of unreachable destinations will be truncated, if needed, to limit this Reply to a single, maximum length HAP message.

Caution: The Change Stream Reply will indicate failure if any aspect of the requested changes did not occur. However, the stream may have been partially modified. Processing is performed in the following phases:

- 0: check for invalid requests;
- 1: drop former recipients that are not in the latest list;
- 2: increase or decrease the stream's bandwidth allocation (decreases are normally successful); then
- 3: extend the stream to any new recipients.

If phase 2 fails, phase 3 is not performed, the Reply Code will indicate an error and the stream parameters will be unchanged. If phase 3 fails, the Address List will contain the destinations, if any, from the latest list that the stream does not reach. Phase 1 only fails if the stream has been suspended (see Notifications) or the WPS is experiencing network connectivity problems.

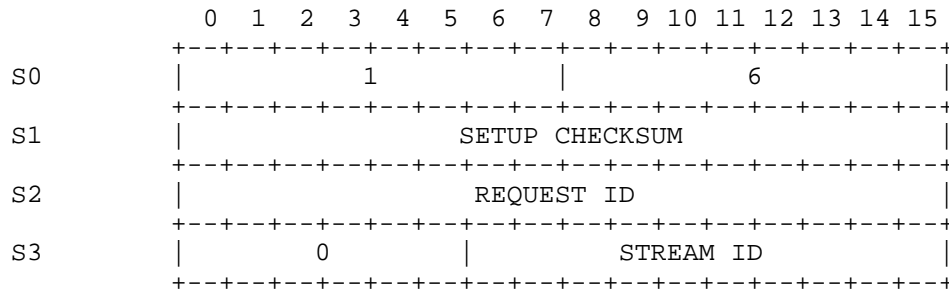

DELETE STREAM REQUEST
Figure 12

S0[0-7] Setup Type = 1 (Request).

S0[8-15] Request Type = 6 (Delete Stream).

S1[0-15] Setup Checksum. (See setup header description.)

S2[0-15] Request ID.

S3[0-5] Reserved. Must be zero.

S3[6-15] Stream ID.

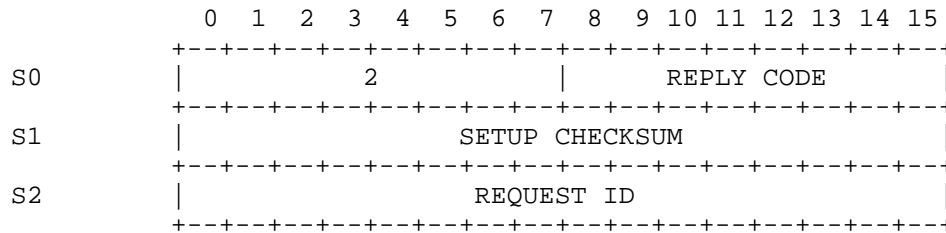

DELETE STREAM REPLY

Figure 13

S0[0-7] Setup Type = 2 (Reply).

S0[8-15] Reply Code. If the request was valid, the Service Agent will have marked the stream for deletion even if the stream resources have not actually been deleted yet.

1 = Stream deleted
 10 = Stream ID nonexistent
 11 = Not creator of stream

S1[0-15] Setup Checksum. (See setup header description.)

S2[0-15] Request ID.

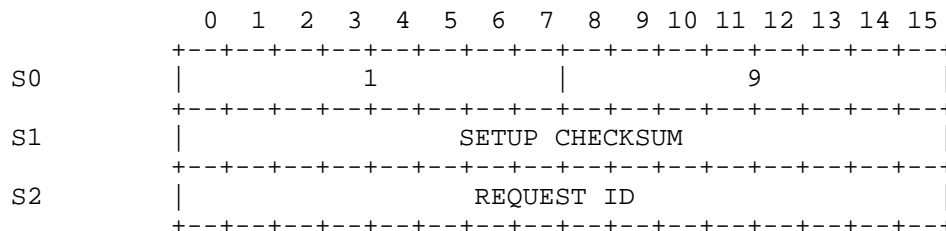

DELETE ALL STREAMS REQUEST

Figure 14

S0[0-7] Setup Type = 1 (Request).

S0[8-15] Request Type = 9 (Delete All Streams).

S1[0-15] Setup Checksum. (See setup header description.)

S2[0-15] Request ID.

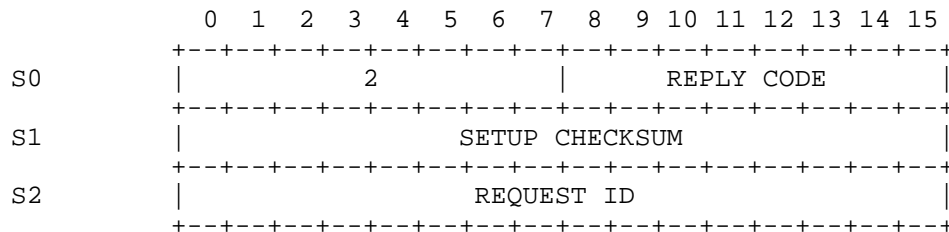

DELETE ALL STREAMS REPLY
Figure 15

S0[0-7] Setup Type = 2 (Reply).

S0[8-15] Reply Code. The Service Agent will have marked all of the host's streams for deletion, even if the stream resources have not actually been deleted yet.

1 = Streams deleted

S1[0-15] Setup Checksum. (See setup header description.)

S2[0-15] Request ID.

6.2. Group Setup Messages

Group (multicast) addressing allows a host to send the same message to N different hosts without having to send N copies of the message. The network duplicates the message as required. In addition to reducing the burden on the originating host, multicasting reduces the load on the network because the network no longer has to carry the duplicates along the common portions of the paths between the source and destinations. Multicasting is particularly recommended for multi-site conferencing and distributed simulations.

Group addresses are dynamically created and deleted via setup messages exchanged between the hosts and the Service Agent. Membership in a group may be any arbitrary subset of the network hosts. A datagram message or stream message addressed to a group is delivered to all hosts that are members of that group (exception: stream messages sent to a group address that includes hosts the

stream was not set up to reach). The group setup messages, each of which has a Request and a Reply, are Create Group, Delete Group, Join Group, Leave Group, Add Group Member, and Remove Group Member.

Figure 16 shows a typical use of group setup messages. The figure illustrates a scenario of exchanges between three hosts and the Service Agent. In the scenario one host, Host A, creates a group which is joined by hosts B and C. The hosts then exchange some data messages using the group address. Note that multicast messages are not returned to their originator. Hosts A and C then leave the group, and Host B decides to delete the group. As in the scenario in Section 6.1, A/R indications have been omitted for clarity.

Part of the group creation procedure involves the Service Agent returning to the creating host a 48-bit key along with the 16-bit group address. The creating host must pass the key along with the group address to other hosts that want to join the group. These other hosts must supply the key along with the group address in their Join Group Requests. The key is used by the network to authenticate these operations and thereby minimize the probability that unwanted hosts will deliberately or inadvertently become members of the group. The procedure used by a host to distribute the group address and key is not within the scope of HAP.

In the figure below, the network Service Agent is pictured as a single entity for simplicity.

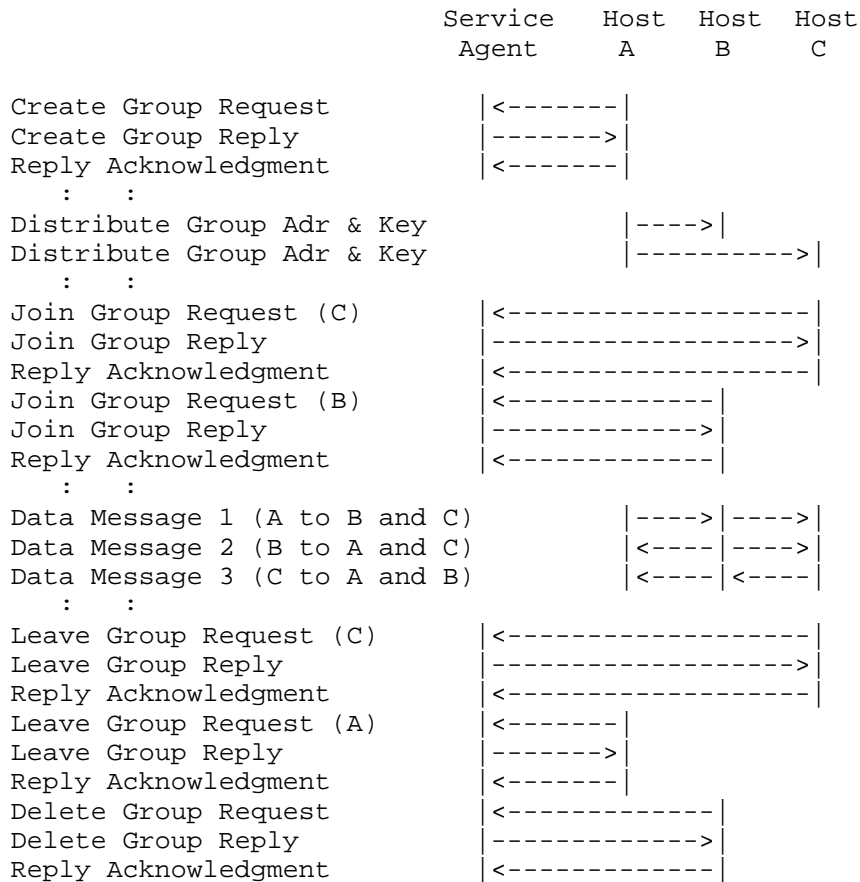

GROUP EXAMPLE
Figure 16

An alternative method of adding and removing group members is the use of Add Group Member and Remove Group Member. These setup requests allow hosts that are already members of the group to add or delete other hosts.

The Setup requests Join Group, Leave Group, Add Group Member, Remove Group Member, and Delete Group are authenticated using the 48-bit key. Leave Group and Remove Group Member will remove a host from the group membership list but will not alter the existence of the group. Delete Group expunges all knowledge of the group from the network. HAP permits any host with the proper key to delete the group at any time. Thus, group addresses can be deleted even if the host which originally created the group has left the group or has crashed. Moreover, groups may exist for which there are currently no members

because each member has executed a Leave while none has executed a Delete. It is the responsibility of the hosts to coordinate and manage the use of group addresses.

Note that group addresses, like all other resources allocated by the network, may be reclaimed by the network if unused for too long. Currently, if no traffic is sent to the group address in a 6 minute interval, the network may delete the group and notify all members that the group no longer exists.

The Create Group Request (Figure 17) is used to establish a multicast address. After the network has processed the Create Group Request, the Service Agent will respond by sending a Create Group Reply (Figure 18) to the host.

A host may become a member of a group, once it knows the group address and the 48-bit key, by sending the Service Agent the Join Group Request message (Figure 19). The Service Agent will respond to the Join Group Request with a Join Group Reply (Figure 20). The host which creates a group automatically becomes a member of that group without any need for an explicit Join Group Request.

A member host may add another host to the group by sending the Service Agent the Add Group Member Request message (Figure 21). The Service Agent will respond with an Add Group Member Reply (Figure 22).

At any time after becoming a member of a group, a host may choose to drop out of the group. To do this, the host sends the Service Agent a Leave Group Request (Figure 23). The Service Agent will respond with a Leave Group Reply (Figure 24).

One member host may expel another member of the group by sending the Service Agent the Remove Group Member Request message (Figure 25). The Service Agent will respond with a Remove Group Member Reply (Figure 26).

A host can delete an existing group via a Delete Group Request (Figure 27). The Service Agent will respond with a Delete Group Reply (Figure 28). The Service Agent will also send the other members of the group, if any, a notification that the group has been deleted (see Section 6.3).

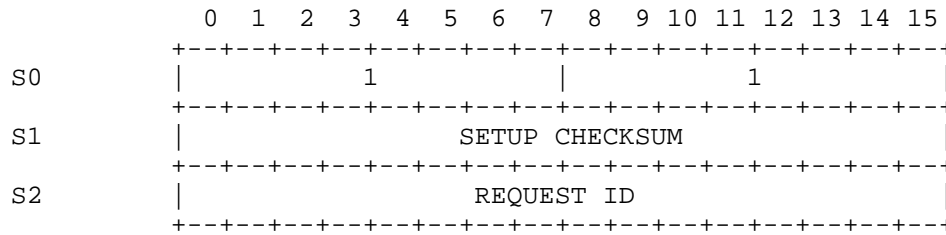

CREATE GROUP REQUEST
Figure 17

- S0[0-7] Setup Type = 1 (Request).
- S0[8-15] Request Type = 1 (Create Group).
- S1[0-15] Setup Checksum. (See setup header description.)
- S2[0-15] Request ID.

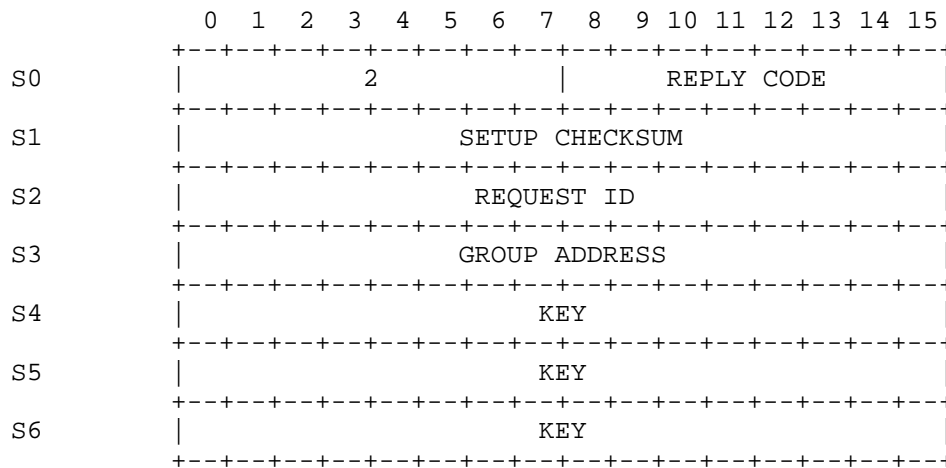

CREATE GROUP REPLY
Figure 18

- S0[0-7] Setup Type = 2 (Reply).

S0[8-15] Reply Code.

0 = Group created
 8 = Network trouble
 17 = Insufficient network resources
 22 = Reply lost in network

S1[0-15] Setup Checksum. (See setup header description.)

S2[0-15] Request ID.

S3[0-15] Group Address. This field contains the 16-bit multicast address that any group member may use to reach the other group members. Multicast addresses are dynamically assigned by the network.

S4-S6 Key. This field contains a 48-bit key assigned by the network which is associated with the group address. It must be provided for subsequent Join Group, Leave Group, Add Group Member, Remove Group Member, and Delete Group requests which reference the group address.

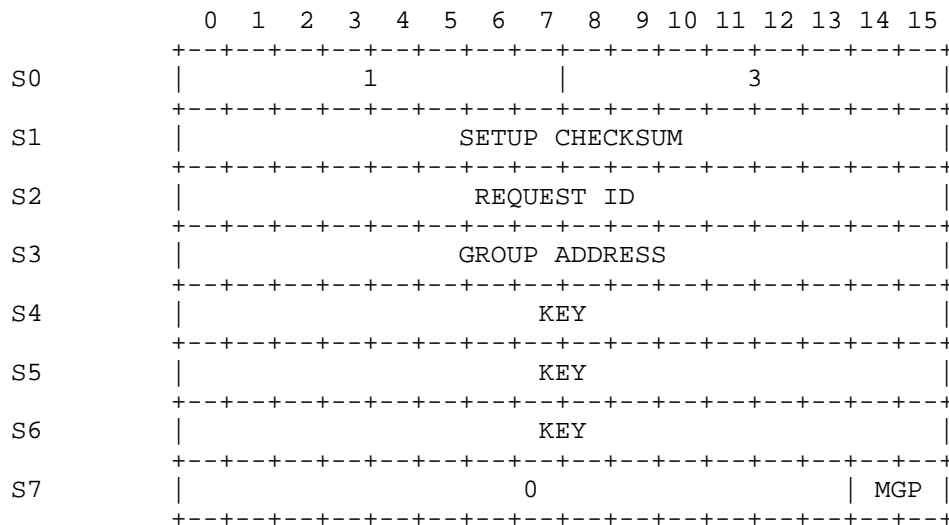

JOIN GROUP REQUEST
 Figure 19

- S0[0-7] Setup Type = 1 (Request).
- S0[8-15] Request Type = 3 (Join Group).
- S1[0-15] Setup Checksum. (See setup header description.)
- S2[0-15] Request ID.
- S3[0-15] Group Address. This is the group that the host wishes to join. Upon successfully joining the group, the host may send messages to the group and will receive messages sent to the group when those messages have a priority of MGP or higher.
- S4-S6 Key. This is the key associated with the group address.
- S7[0-13] Reserved. Must be zero.
- S7[14-15] Minimum group message priority. The host will not receive messages sent to the group that have a message priority less than MGP. Send another Join Group Request message to change the minimum priority.

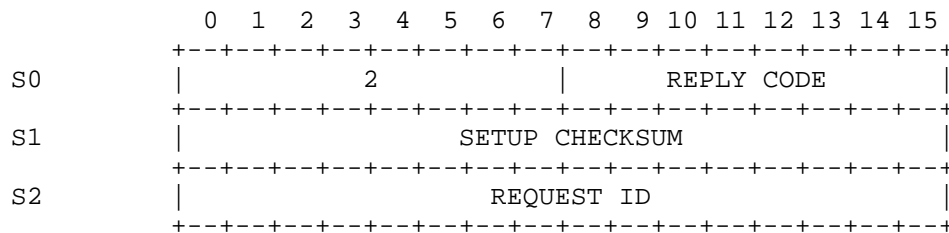

JOIN GROUP REPLY
Figure 20

- S0[0-7] Setup Type = 2 (Reply).
- S0[8-15] Reply Code.
- 2 = Host added to group
 - 9 = Bad key
 - 10 = Group address nonexistent
 - 17 = Insufficient network resources

S1[0-15] Setup Checksum. (See setup header description.)

S2[0-15] Request ID.

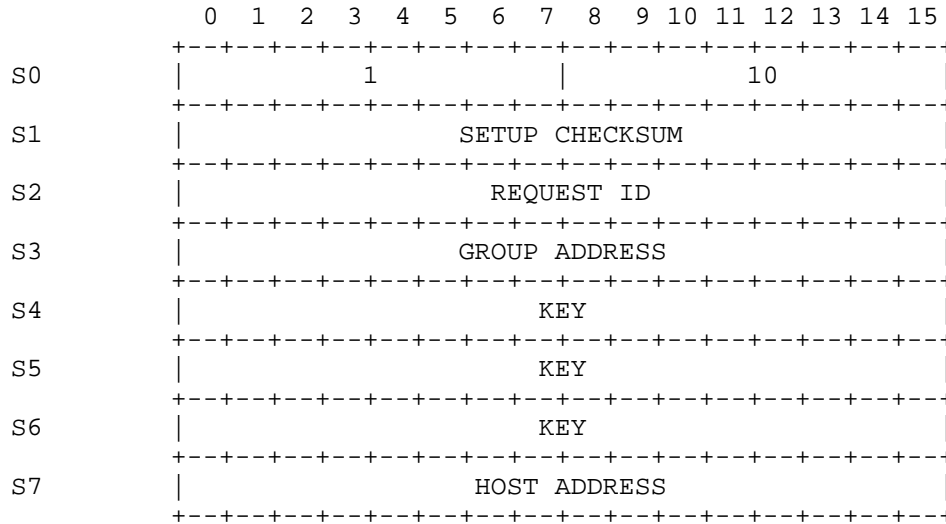

ADD GROUP MEMBER REQUEST
Figure 21

S0[0-7] Setup Type = 1 (Request).

S0[8-15] Request Type = 3 (Join Group).

S1[0-15] Setup Checksum. (See setup header description.)

S2[0-15] Request ID.

S3[0-15] Group Address. This is the group the host will join. Upon successfully joining the group, the host may send messages to the group and will receive messages sent to the group by other hosts (the initial minimum priority will be 0).

S4-S6 Key. This is the key associated with the group address.

S7[0-15] Host address. The network address of the host to add

to the group.

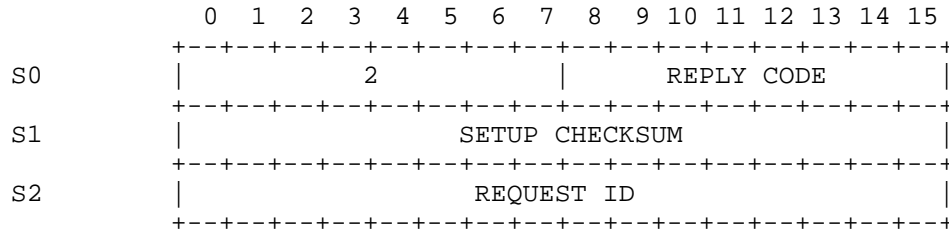

ADD GROUP MEMBER REPLY
Figure 22

S0[0-7] Setup Type = 2 (Reply).

S0[8-15] Reply Code.

- 2 = Host added to group (or was already a member)
- 9 = Bad key
- 10 = Group address nonexistent
- 11 = Requestor is not a member of the group
- 17 = Insufficient network resources
- 22 = Reply lost in network
- 24 = Host address was invalid

S1[0-15] Setup Checksum. (See setup header description.)

S2[0-15] Request ID.

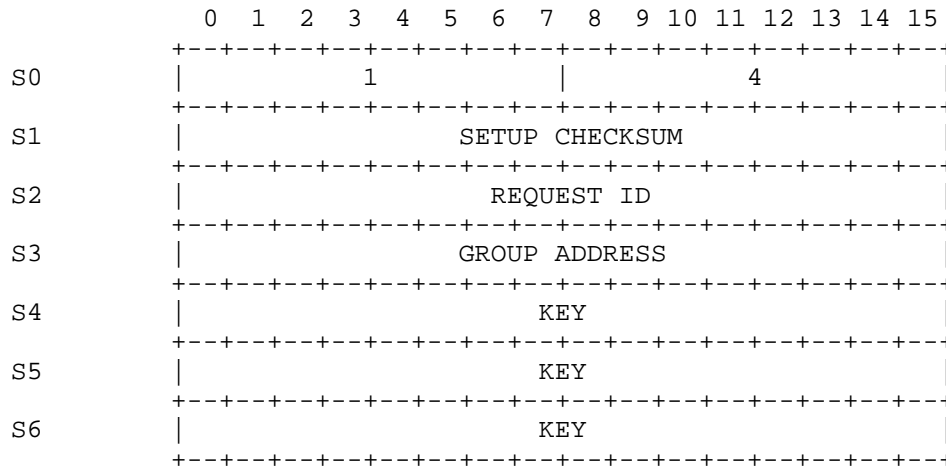

LEAVE GROUP REQUEST
Figure 23

- S0[0-7] Setup Type = 1 (Request).
- S0[8-15] Request Type = 4 (Leave Group).
- S1[0-15] Setup Checksum. (See setup header description.)
- S2[0-15] Request ID.
- S3[0-15] Group Address. This is the group that the host wishes to cease being a member of. After leaving the group, the host will cease receiving messages sent to the group and will be unable to send to the group.
- S4-S6 Key. This is the key associated with the group address.

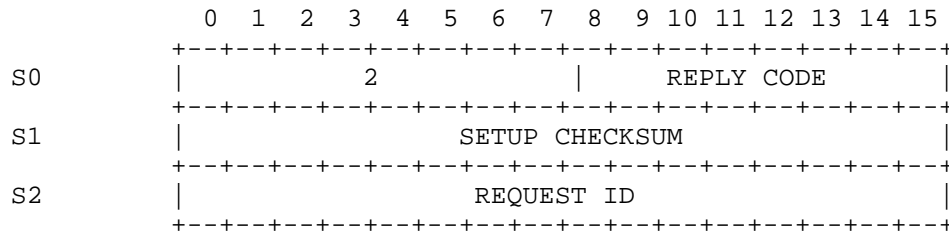

LEAVE GROUP REPLY
Figure 24

S0[0-7] Setup Type = 2 (Reply).

S0[8-15] Reply Code.

3 = Host deleted from group
9 = Bad key
10 = Invalid group address
11 = Not member of group
17 = Insufficient network resources

S1[0-15] Setup Checksum. (See setup header description.)

S2[0-15] Request ID.

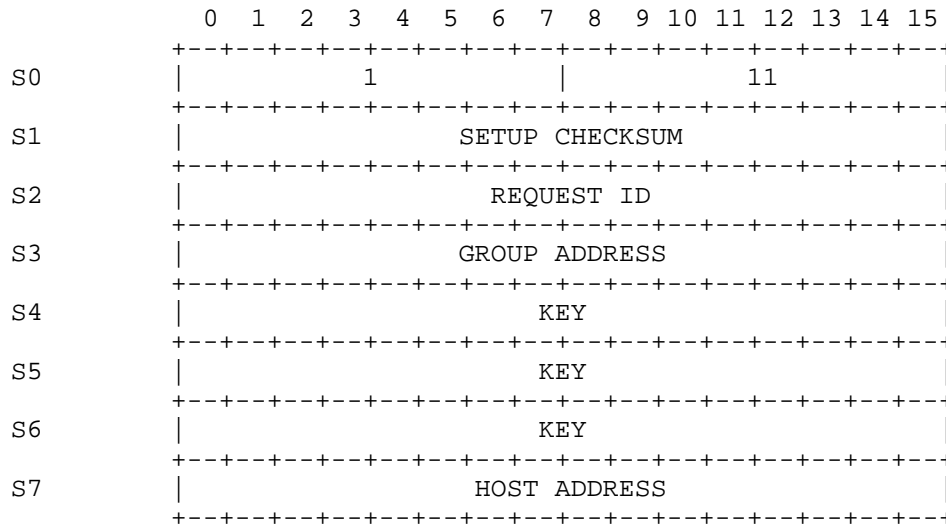

REMOVE GROUP MEMBER REQUEST
Figure 25

- S0[0-7] Setup Type = 1 (Request).
- S0[8-15] Request Type = 4 (Leave Group).
- S1[0-15] Setup Checksum. (See setup header description.)
- S2[0-15] Request ID.
- S3[0-15] Group Address. This is the group from which the host should be removed. After leaving the group, that host will cease receiving messages sent to the group and will be unable to send to the group.
- S4-S6 Key. This is the key associated with the group address.
- S7[0-15] Host address. The network address of the host to remove from the group.

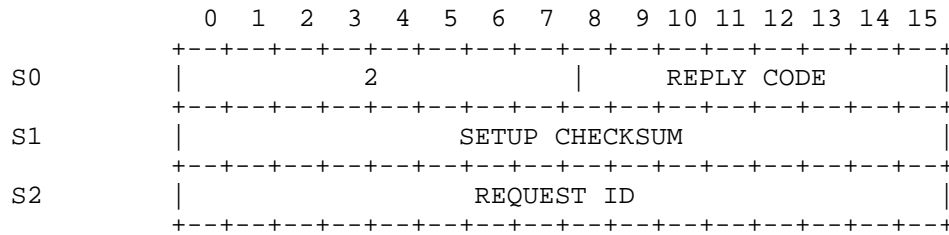

REMOVE GROUP MEMBER REPLY
Figure 26

S0[0-7] Setup Type = 2 (Reply).

S0[8-15] Reply Code.

3 = Host deleted from group (or was not a member)
9 = Bad key
10 = Invalid group address
11 = Requestor is not a member of the group
17 = Insufficient network resources
22 = Reply lost in network
24 = Host address was invalid

S1[0-15] Setup Checksum. (See setup header description.)

S2[0-15] Request ID.

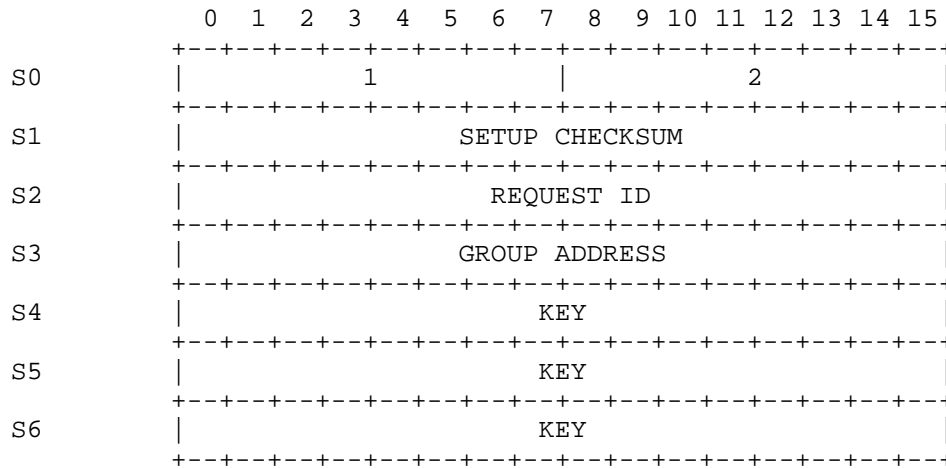

DELETE GROUP REQUEST
Figure 27

- S0[0-7] Setup Type = 1 (Request).
- S0[8-15] Request Type = 2 (Delete Group).
- S1[0-15] Setup Checksum. (See setup header description.)
- S2[0-15] Request ID.
- S3[0-15] Group Address. This is the multicast address to delete. If the group is deleted, the other remaining members of the group, if any, will be notified of the group's deletion.
- S4-S6 Key.

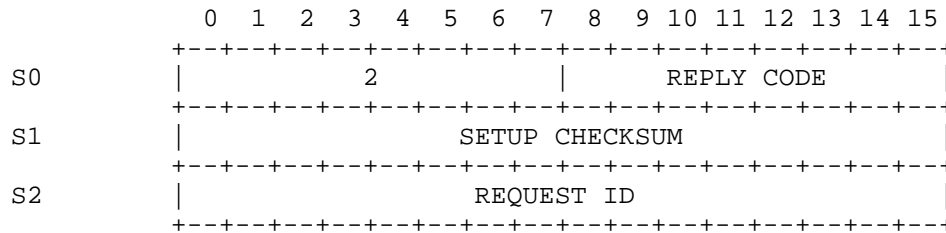

DELETE GROUP REPLY
Figure 28

S0[0-7] Setup Type = 2 (Reply).

S0[8-15] Reply Code.

1 = Group deleted
8 = Network trouble
9 = Bad key
10 = Invalid group address
17 = Insufficient network resources
22 = Reply lost in network

S1[0-15] Setup Checksum. (See setup header description.)

S2[0-15] Request ID.

6.3. Notifications

Notifications are Setup exchanges initiated by the WPS to inform a host of changes in the status of a network resource. The format of Notification messages is shown in Figure 29.

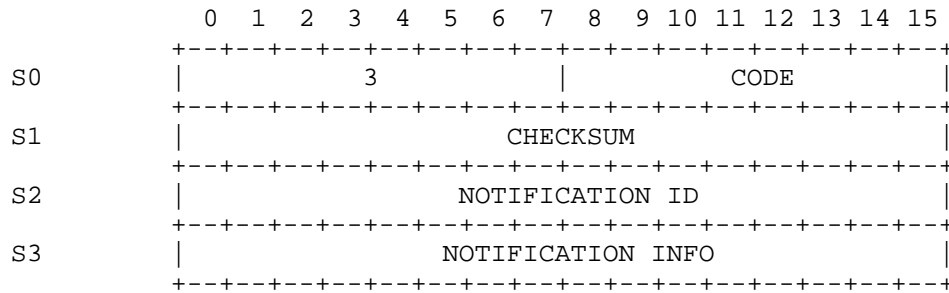

NOTIFICATION MESSAGE
Figure 29

S0[0-7] Message Type = 3 (Notification).

S0[8-15] Code. This indicates what the Notification signifies.

- 0 = Stream suspended
- 1 = Stream resumed
- 2 = Stream deleted
- 3 = Group deleted by a host
- 4 = Group deleted by network
- 5 = All streams deleted
- 6 = All groups deleted
- 7 = Group changed by a host
- 8 = Group changed by network

S1[0-15] Checksum. (See Service Agent Header description.)

S2[0-15] Notification ID.

S3[0-15] Notification Information.

For notification types 0, 1, and 2, NOTIFICATION INFO contains the following:

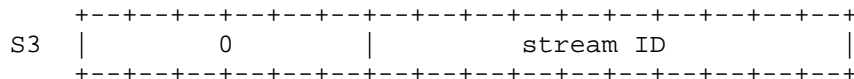

For notification types 3, 4, 7, and 8, NOTIFICATION INFO contains the following:

```

      +-----+-----+-----+-----+-----+-----+-----+-----+
S3  |                                     group address                                     |
      +-----+-----+-----+-----+-----+-----+-----+-----+

```

For notification types 5 and 6, which refer to all streams or groups, NOTIFICATION INFO is zero.

6.4. Setup Acknowledgments

The host must acknowledge receipt of Setup Replies and Notifications from the Service Agent, as described earlier. The format for the Setup Acknowledgment message is shown in Figure 30.

```

      0  1  2  3  4  5  6  7  8  9 10 11 12 13 14 15
      +-----+-----+-----+-----+-----+-----+-----+-----+
S0  |           0           |           CODE           |
      +-----+-----+-----+-----+-----+-----+-----+-----+
S1  |                                     CHECKSUM                                     |
      +-----+-----+-----+-----+-----+-----+-----+-----+
S2  |                                     MESSAGE ID                                     |
      +-----+-----+-----+-----+-----+-----+-----+-----+

```

SETUP ACKNOWLEDGMENT
Figure 30

S0[0-7] Message Type = 0 (Acknowledgment).

S0[8-15] Code. This field indicates the type of acknowledgment.

0 = Reply acknowledgment
1 = Notification acknowledgment

S1[0-15] Checksum. (See Service Agent Header description.)

S2[0-15] Message ID. This is either a Request ID or a Notification ID.

6.5. Information Request / Reply Messages

The host may obtain information about WPS state and about what resources the WPS currently has allocated for the host by sending an Information Request message to the Service Agent. The Information Reply that is returned will enable the host to determine 1) what

resources the WPS has allocated to the host, and 2) the current state of the network and, possibly, certain network parameters. This allows the host to refrain from trying to use resources it no longer has, and to regain information it may have lost on its network resources. This communication also informs the host of the network state so that it may make priority and routing decisions.

Each Information Request (Figure 31) and Information Reply (Figure 32) message deals with a single type of resource at a time. The header of the Information Reply message contains the number of entries within the message, the number of 16-bit words in each entry, and an instance of the appropriate information structure for each resource the Information Reply message describes. These information structures are described in Figures 33 and 34.

Future versions of the HAP protocol may permit queries about network connectivity, estimated delay to a specified destination address under specified conditions, etc. This is a section of the protocol that is likely to expand in the future. Extensions are expected to be backward compatible provided implementors do not hard code the size of the returned information entries.

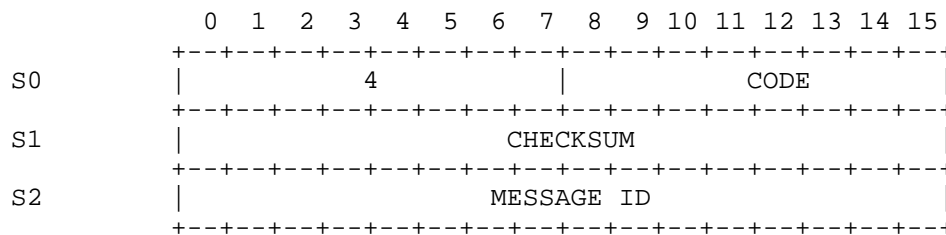

INFORMATION REQUEST MESSAGE

Figure 31

S0[0-7] Message type = 4 (Information Request).

S0[8-15] Code. This field identifies the Information Request Type.

- 1 = streams owned by host
- 2 = groups to which the host belongs

S1[0-15] Checksum. (See Service Agent Header description.)

S2[0-15] Message ID. This field is assigned by the host to uniquely identify outstanding requests (Request ID). This ID is copied into Information Replies by the Service Agent.

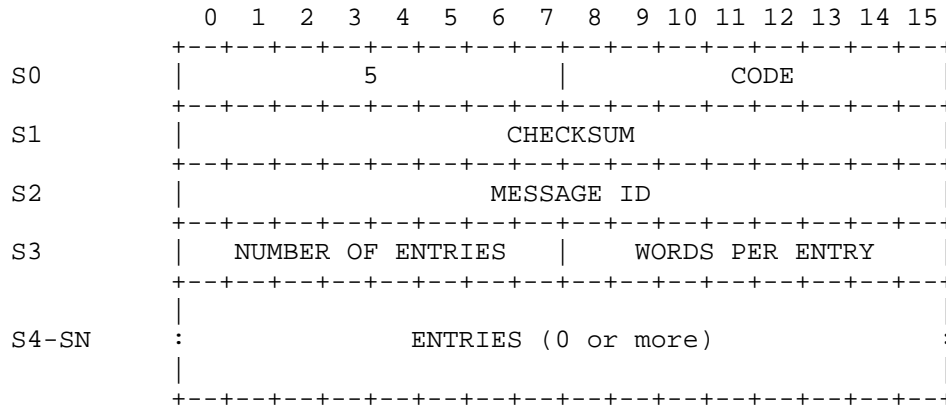

INFORMATION REPLY MESSAGE
Figure 32

S0[0-7] Message type = 5 (Information Reply).

S0[8-15] Code. This field identifies the Information Reply Type.

- 1 = streams owned by host
- 2 = groups to which the host belongs
- 3 = error in Information Request message
- 4 = network trouble
- 5 = access not allowed

S1[0-15] Checksum. (See Service Agent Header description.)

S2[0-15] Message ID. This field is assigned by the host in the Information Request message to uniquely identify outstanding requests. This ID is copied into the Information Reply message by the Service Agent.

S3[0-7] Number of entries included in the Information Reply message.

S3[8-15] Number of 16-bit words per entry.

S4-SN Zero or more instances of either the stream information or group information structure.

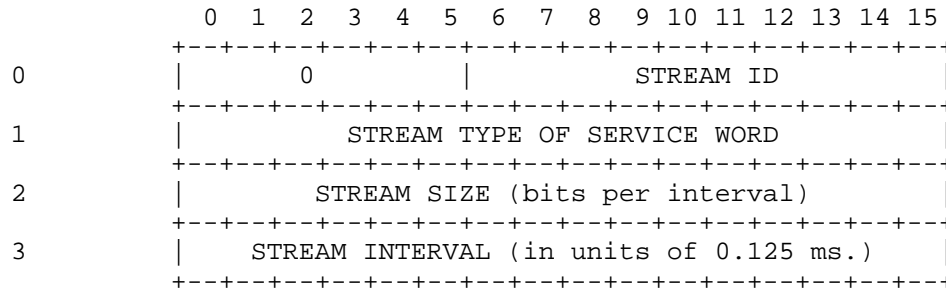

STREAM INFORMATION
Figure 33

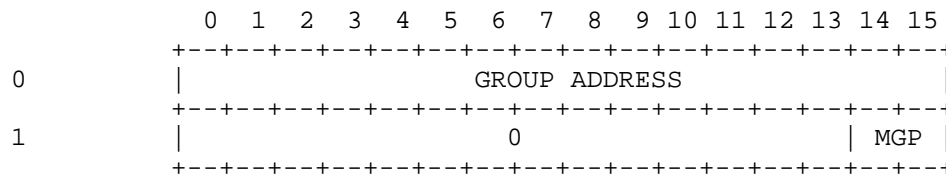

GROUP INFORMATION
Figure 34

7. Host Access Link Monitoring

While the access link is operating, statistics on traffic load and error rate are maintained by the host and WPS. Once a second, the host and WPS exchange this information via Status messages (Figure 35). This periodic exchange of Status messages permits both ends of the link to monitor flows in both directions. The WPS also reports these monitoring statistics to the Network Operations Center (NOC). If either host or WPS fails to receive Status messages for ten seconds, the link will be restarted (see Section 8).

The link restart procedure initializes all internal WPS counts and statistics for that link to zero. As data and control messages are processed, counts are updated to reflect the total number of messages sent, messages received correctly, and messages received with different classes of errors since the last link restart. Whenever a Status message arrives, a snapshot is taken of the local WPS counts. The local receive counts, in conjunction with a sent count contained in the received Status message, permits the computation of traffic statistics in the one second update interval assuming that the set of counts at the time of the previous monitoring report have been saved. By including in the Status message sent (in the opposite direction) the receive counts and the received sent count that was used with them, the transmitting end of the access link as well as the receiving end can determine the link performance from sender to receiver.

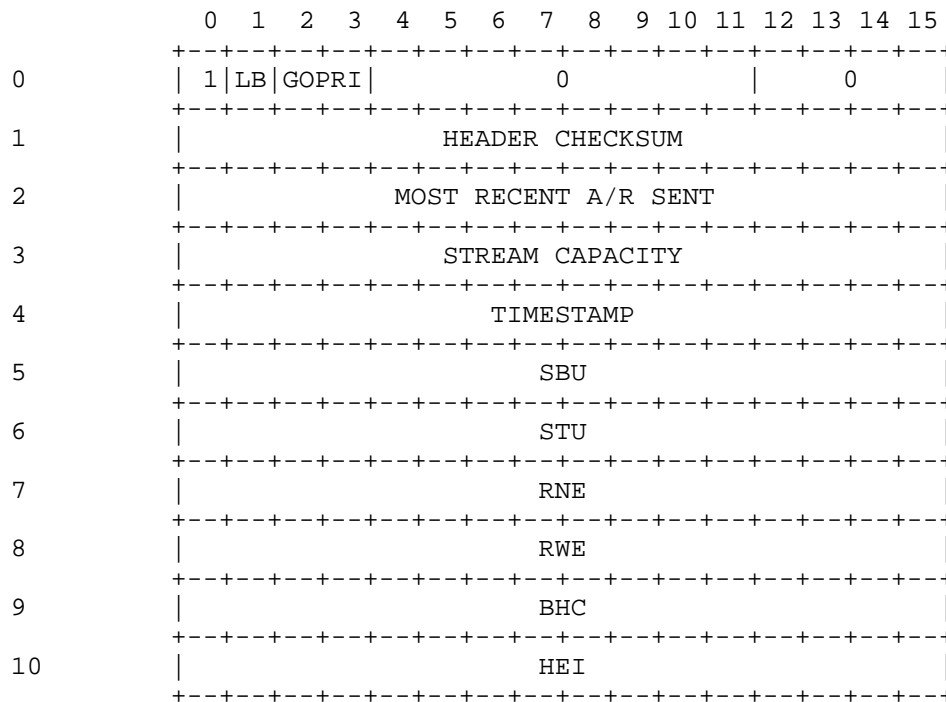

STATUS MESSAGE
Figure 35

- 0[0] Message Class = 1 (Control Message).
- 0[1] Loopback indicator.
- 0[2-3] Go-Priority.
- 0[4-11] Reserved. Must be zero.
- 0[12-15] Control Message Type = 0 (Status).
- 1[0-15] Header Checksum. The checksum is the 2's-complement of the 2's-complement sum of words 0-10 (excluding the checksum word itself).
- 2[0-15] Most Recent A/R Sent. This field is a duplicate of the most recent acceptance/refusal word. It is included in the periodic Status message in case previous transmissions containing A/R information were lost.
- 3[0-15] Stream Capacity. When sent by the WPS, this field indicates how much stream capacity is unused, in units of data bits per millisecond. There is no guarantee that a request for a stream of this size will succeed. Since available capacity depends directly on a variety of parameters that can be selected by the user, the value of this field is the maximum capacity that could be achieved if existing streams were expanded at low reliability. This field is not meaningful in messages sent from the host to the WPS and must be set to zero.
- 4[0-15] Timestamp. This field indicates the time that the Status message was generated. When sent by a WPS, the time is in units of seconds since the last link restart. The host should also timestamp its messages in units of seconds.
- 5[0-15] Sent By Us. Count of messages sent by us since the last link restart (not including this one).
- 6[0-15] Sent To Us. Count of messages sent to us since the last link restart. This is the count from word 5 of the last Status message received.
- 7[0-15] Received, No Errors. This is the count of messages received without errors (since the last link restart) at the time that the last Status message was received.
- 8[0-15] Received With Errors. This is the count of messages

received with errors (since the last link restart) at the time the last Status message was received.

9[0-15] Bad Header Checksums. This is the count of messages received with bad header checksums (since the last link restart) at the time the last Status message was received.

10[0-15] Hardware Error Indication. This is the count of messages received with hardware CRC errors or hardware interface error indications (since the last link restart) at the time the last Status message was received.

8. Initialization

The Host Access Protocol uses a number of state variables that must be initialized in order to function properly. These variables are associated with the send and receive message numbers used by the acceptance/refusal mechanism and the statistics maintained to support link monitoring. Link initialization should be carried out when a machine is initially powered up, when it does a system restart, when the ON state (see below) times out, when a loopback condition times out (see Section 9), or whenever the link transitions from non-operational to operational status.

Initialization is accomplished by the exchange of Restart Request (RR) and Restart Complete (RC) messages between a host and a WPS. Either end (or both ends) may send an initial RR, and both ends must have sent and received an RC message in order to declare the link up. Because the RC message is a reply (to an RR or RC), receipt of an RC message by both ends guarantees that the physical link is operating in both directions. The initialization state diagram that must be implemented by both WPS and host is shown in Figure 36. Five states are identified in the state diagram:

OFF Entered upon recognition of a requirement to restart. The interface in the Host or WPS can recognize this requirement itself or be forced to restart by receipt of an RR message from the other end while in the ON state.

INIT Local state variables have been initialized but no RC messages have yet been sent or received. If receipt of an RR initiated the restart, or if an RR has been received since this restart began, send an RC (optional, reduces startup time). Otherwise, send an RR to alert the other end of the restart.

- RR-SNT A request to reinitialize (RR) has been sent to the other end, but no RR or RC messages have been received.
- RC-SNT An RC has been sent to the other end in response to an RR. The interface is waiting to receive an RC.
- ON RC messages have been both sent and received. Local counters have been zeroed. Data and control messages can now be exchanged between the WPS and host.

All states have 10-second timeouts (not illustrated) which return the protocol to the OFF state. The occurrence of any events other than those indicated in the diagram are ignored.

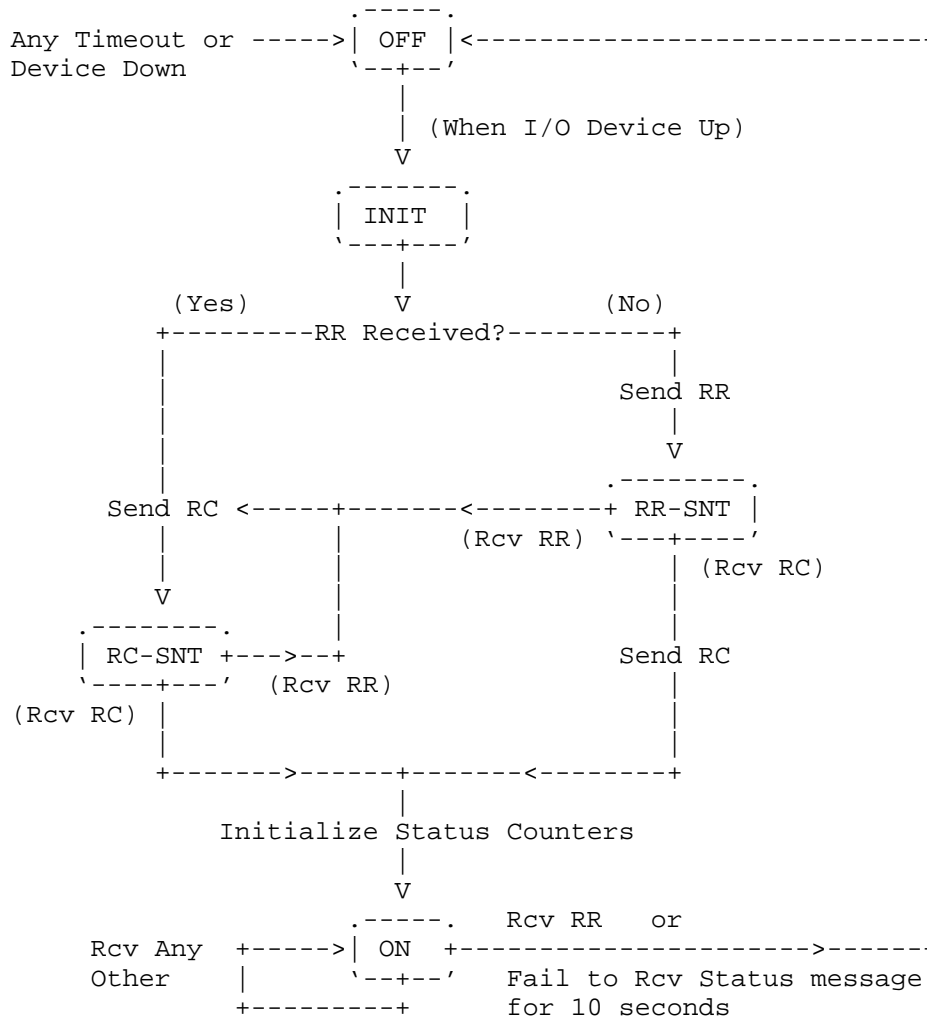

HAP LINK RESTART STATE DIAGRAM
Figure 36

The Restart Request control message (Figure 37) is sent by either a host or a WPS when it wishes to restart a link. The Restart Request causes all the monitoring statistics reported in the Status Message to be reset to zero and stops all traffic on the link in both directions. The Restart Complete message (Figure 38) is sent in response to a received Restart Request or Restart Complete to complete link initialization. The Restart Complete carries a field used by the host to enable or disable the acceptance/refusal

mechanism for the link being restarted (see Section 5). After the Restart Complete is processed, traffic may flow on the link.

The allocation and state of network resources (streams and groups) are separate from the state of the host's access link(s) to the WPS. The Information Request message (see Section 6.5) may be used by a host to determine what resources it has. If the "SL" bit is set in the Restart Complete message from the WPS, and if the host believes it has resources allocated to it, the host is strongly encouraged to use an Information Request to verify that it still has its resources.

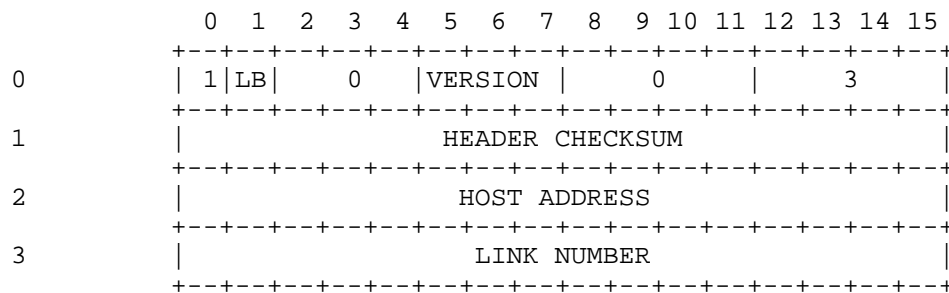

RESTART REQUEST
Figure 37

- 0[0] Message Type = 1 (Control Message).
- 0[1] Loopback indicator.
- 0[2-4] Reserved. Must be zero.
- 0[5-7] HAP version number. Use 1. Use of zero invokes backward compatibility code (see Appendix B).
- 0[8-11] Reserved. Must be zero.
- 0[12-15] Control Message Type = 3 (Restart Request).
- 1[0-15] Header Checksum. The checksum is the 2's-complement of the 2's-complement sum of words 0-3 (excluding the checksum word itself).
- 2[0-15] Host Address. The WPS inserts the primary network address of the host. The host may insert any of its

network addresses in this field (hosts may have more than one logical address per physical port). The WPS will only bring up the HAP link if the host address is valid for the port being used.

3[0-15] Link Number. This field contains the sender's identification of the physical link being used. This information is used to identify the link when reporting errors to the Network Operations Center (NOC).

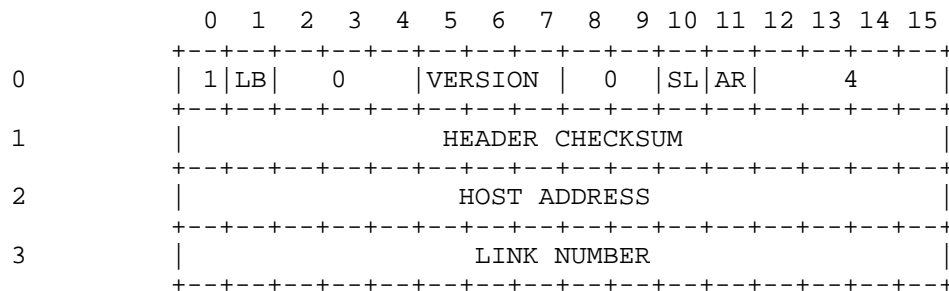

RESTART COMPLETE

Figure 38

- 0[0] Message Type = 1 (Control Message).
- 0[1] Loopback indicator.
- 0[2-4] Reserved. Must be zero.
- 0[5-7] HAP version number. Use 1. Use of zero invokes backward compatibility code (see Appendix B).
- 0[8-9] Reserved. Must be zero.
- 0[10] Service loss alert (boolean) (WPS to host only; host must send zero). If the WPS has any reason to believe that the resources allocated to the host may not match what the host believes is allocated, SL is set to one. If SL is one, a host that believes it owns any resources is strongly encouraged to use an Information Request to verify that the resources are still allocated. SL will be one the first time a link is brought up after a WPS is restarted, and may be set in other cases.

0[11] Acceptance/Refusal Control. This bit is used by the host to enable or disable the acceptance/refusal mechanism for all traffic on the link.

0 = Disable acceptance/refusal

1 = Enable acceptance/refusal

0[12-15] Control Message Type = 4 (Restart Complete).

1[0-15] Header Checksum. Covers words 0-3.

2[0-15] Host Address.

3[0-15] Link Number.

9. Loopback Control

The Host Access Protocol provides a Loopback Request control message which can be used by a WPS or a host to request the remote loopback of its HAP messages. Such requests are usually the result of operator intervention for purposes of system fault diagnosis. For clarity in the following discussion, the unit (WPS or host) requesting the remote loopback is referred to as the "transmitter" and the unit implementing (or rejecting) the loopback is referred to as the "receiver".

When the host access link is remotely looped, all HAP messages will be returned, unmodified, over the access link by the receiver. (Messages that are too long to be valid HAP messages may be discarded instead of being returned.) The receiver will not send any of its own messages to the transmitter while it is implementing the loop. WPS-generated messages are distinguished from host-generated messages by means of the Loopback indicator that is in every HAP message header.

Two types of remote loopback may be requested: loopback at the receiver's interface hardware and loopback at the receiver's I/O driver software. HAP does not specify the manner in which the receiver should implement these loops; additionally, some receivers may use interface hardware which is incapable of looping the transmitter's messages, only allowing the receiver to provide software loops. A receiver may not be able to interpret the transmitter's messages as it is looping them back. If such interpretation is possible, however, the receiver will not act on any of the transmitter's messages other than requests to reinitialize the WPS-host link (Restart Request (RR) control messages; see Section 8.)

When a receiver initiates a loopback condition in response to a

loopback request, it makes an implicit promise to maintain the condition for the duration specified in the Loopback Request message. However, if an unanticipated condition such as a system restart occurs in either the transmitter or the receiver, the affected unit will try to reinitialize the WPS-host link by sending an RR message to the other unit. If the RR message is recognized by the other unit, a link initialization sequence can be completed. This will restore the link to an unlooped condition even if the specified loop duration has not yet expired. If a receiver cannot interpret a transmitter's RR messages, and in the absence of operator intervention at the receiver, the loop will remain in place for its duration.

HAP does not specify the characteristics of any loopback conditions that may be locally implemented by a given unit. An example of such a condition is that obtained when a WPS commands its host interface to loop back its own messages. If such local loop conditions also cause the reflection of messages received from the remote unit, the remote unit will detect the condition via the HAP header Loopback indicator.

A specific sequence must be followed for setting up a remote loopback. It begins after the HAP link has been initialized and a decision is made to request a remote loop. The transmitter then sends a Loopback Request message (Figure 39) to the receiver and waits for either (1) a 10-second timer to expire, (2) a "Can't implement loop" Unnumbered Response message from the receiver, or (3) one of its own reflected messages. If event (1) or (2) occurs the request has failed and the transmitter may, at its option, try again with a new Loopback Request message. If event (3) occurs, the remote loopback condition has been established. While waiting for one of these events, messages from the receiver are processed normally. Note that RR messages arriving from the receiver during this time will terminate the loopback request.

When a receiver gets a Loopback Request message, it either implements the requested loop for the specified duration, or returns a "Can't implement loop" response without changing the state of the link. The latter response would be returned, for example, if a receiver is incapable of implementing a requested hardware loop. A receiver should initiate reinitialization of the link with an RR message(s) whenever a loopback condition times out.

There is one asymmetry that is required in the above sequence to resolve the (unlikely) case where both WPS and host request a remote loopback at the same time. If a WPS receives a Loopback Request message from a host while it is itself waiting for an event of type (1)-(3), it will return a "Can't implement loop" response to the host

and will continue to wait. A host in the converse situation, however, will abort its loopback request and will instead act on the WPS's loopback request.

	0	1	2	3	4	5	6	7	8	9	10	11	12	13	14	15
0		1		LB		GOPRI		0		LOOP TYPE		8				
1		HEADER CHECKSUM														
2		LOOP DURATION														

LOOPBACK REQUEST
Figure 39

- 0[0] Message Type = 1 (Control Message).
- 0[1] Loopback indicator.
- 0[2-3] Go-Priority.
- 0[4-7] Reserved. Must be zero.
- 0[8-11] Loop Type. This field indicates the type of loop that is being requested as follows:
 - 0 = Undefined
 - 1 = Loop at interface (hardware loop)
 - 2 = Loop at driver (software loop)
 - 3-15 = Undefined
- 0[12-15] Control Message Type = 8 (Loopback Request).
- 1[0-15] Header Checksum. The checksum is the 2's-complement of the 2's-complement sum of words 0-2 (excluding the checksum word itself).
- 2[0-15] Loop Duration. The transmitter of a Loopback Request message uses this field to specify the number of seconds that the loop is to be maintained by the receiver.

10. Other Control Messages

Before a WPS or a host voluntarily disables a WPS-host link, it should send at least one Link Going Down control message (Figure 40) over that link. HAP does not define the action(s) that should be taken by a WPS or a host when such a message is received; informing the Network Operations Center (NOC) and/or the network users of the impending event is a typical course of action. Note that each Link Going Down message only pertains to the WPS-host link that it is sent over; if a host and a WPS are connected by multiple links, these links may be selectively disabled.

A No Operation (NOP) control message (Figure 41) may be sent at any time by a WPS or a host. A NOP message contains up to 32 words of arbitrary data which are undefined by HAP. NOP messages may be required in some cases to clear the state of the WPS-host link hardware.

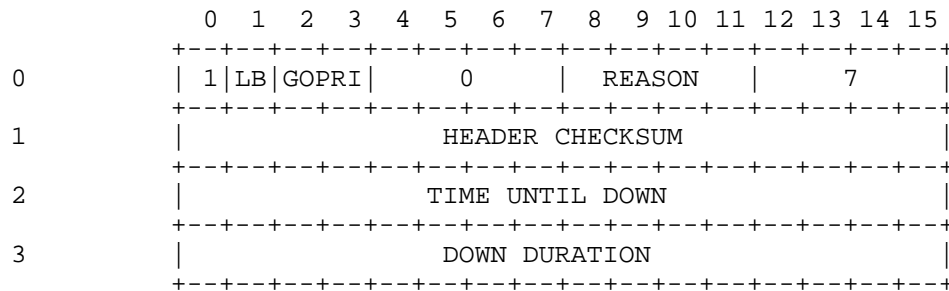

LINK GOING DOWN
Figure 40

- 0[0] Message Type = 1 (Control Message).
- 0[1] Loopback indicator.
- 0[2-3] Go-Priority.
- 0[4-7] Reserved. Must be zero.
- 0[8-11] Reason. This field is used by the WPS or the host to indicate the reason for disabling this WPS-host link as follows:

0 = Cancel previous notice, not going down
 1 = Unspecified reason
 2 = Scheduled PM
 3 = Scheduled hardware work
 4 = Scheduled software work
 5 = Emergency restart
 6 = Power outage
 7 = Software breakpoint
 8 = Hardware failure
 9 = Not scheduled up
 10 = Last warning: The WPS or host will disable
 the link in 10 seconds
 11-15 = Undefined

- 0[12-15] Control Message Type = 7 (Link Going Down).
- 1[0-15] Header Checksum. The checksum is the 2's-complement of the 2's-complement sum of words 0-3 (excluding the checksum word itself).
- 2[0-15] Time Until Down. This field specifies the amount of time remaining until the WPS or host disables the link (in minutes). An entry of zero indicates that there is less than a minute remaining.
- 3[0-15] Down Duration. This field specifies the amount of time that the WPS-host link will be down (in minutes). An entry of zero indicates that the down duration will be less than a minute. An entry of -1 (all bits set) indicates an indefinite down duration.

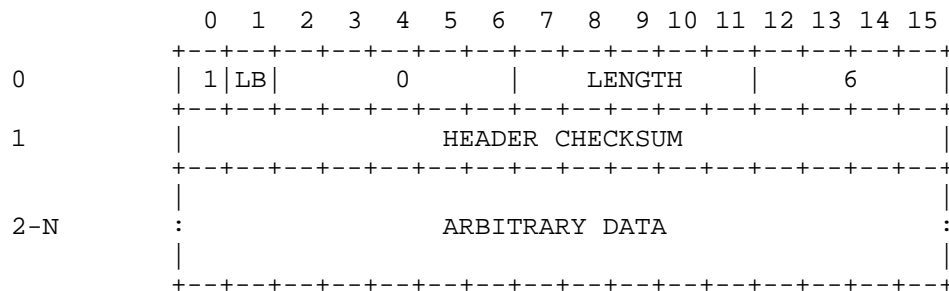

NO OPERATION (NOP)
Figure 41

- 0[0] Message Type = 1 (Control Message).
- 0[1] Loopback indicator.
- 0[2-6] Reserved. Must be zero.
- 0[7-11] Length. The number of words of arbitrary data.
- 0[12-15] Control Message Type = 6 (NOP).
- 1[0-15] Header Checksum. The checksum is the 2's-complement of the 2's-complement sum of words 0-N (excluding the checksum word itself).
- 2-N Arbitrary Data. Up to 32 words of data may be sent. The data are undefined by HAP.

11. Appendix A -- Future Extensions

The extensions to HAP described below are included to provide additional context for the understanding of HAP's current capabilities, as well as suggest how HAP may be enhanced in the future to provide better support for multi-site conferencing. These capabilities are not supported by TWBNET.

One change under consideration is the addition of a "conference" resource, which would own some number of streams and groups and improve the network's ability to meet the needs of video conference users. A single request to modify the "conference", such as to add a new member, would result in modifying all the streams in the conference to include the new member, modifying the conference's primary group address to add the new member, etc., in a single network operation. Such a capability would not only simplify conference resource management for hosts, but also reduce the number of network setup operations, permit more nearly "atomic" decisions of whether a particular conference modification is possible, and reduce the problem of recovery if modification is not possible.

Another change under consideration is the addition of "shared streams." This capability would allow hosts to share a single allocation of network bandwidth (and other resources) wherever the streams shared a common communication path. Hosts using a shared stream must be willing to restrict their total transmission rate to the rate of the shared bandwidth. Multi-site conferences could use such a capability to avoid allocating full bandwidth for voice data for all conference members. Instead, bandwidth for, say, four active voices at once could be allocated and shared, and voice messages would only be lost when more than four people tried to talk at once.

The Create Shared Stream Request would use a different request code than Create Stream Request, and the setup message would likely contain at least one additional field to identify the set of shared streams. Change and Delete Stream requests could be used for both shared and non-shared streams.

12. Appendix B -- Backward compatibility

The WPS will support the use of HAP version 0 by hosts until all hosts have upgraded to version 1. The WPS determines which HAP version the host is using by examining the Restart Request and/or Restart Complete control messages sent by the host to the WPS. If the host initiates a restart and thus sends both a Restart Request and a Restart Complete, and if the HAP version numbers in the two messages differ, the version number in the Restart Complete will prevail. The WPS will always set the version number to 1. If the host sends 0 in the version number field, version 0 compatibility mode will be invoked.

Version 0 of HAP did not contain the PROTOCOL ID field in the datagram and stream message headers. Instead, the IL bit in the Type of Service word was used to indicate the presence or absence of an Internet Protocol (IP) header (any version number) following the HAP header. This is the original description of that bit:

- 3[1] Internet/Local Flag. This flag is set by a source host to specify to a destination host whether the data portion of the message contains an Internet Protocol (IP) header [3]. This field is passed transparently by the source and destination WPSen for traffic between network hosts. This field is examined by WPS Agents in order to support Internet operation.

0 = Internet
1 = Local

Conversion Algorithms

Link control messages (e.g., Restart Request) do not require conversion. Datagram and stream messages sent by or to a host running HAP version 0 will be converted by the WPS. Message conversion will probably cause the maximum throughput of hosts using HAP version 0 to be somewhat lower than that of hosts using HAP version 1.

HAP version 0 used the IL bit in the HAP Type of Service word to indicate the presence or absence of an IP header. Version 1 uses the Protocol ID field. To convert host-to-WPS messages, the IL bit will

be cleared, and the protocol ID field will be inserted, with the value indicated:

IL was	Destination	Protocol ID set to:
-----	-----	-----
0	any	HAP_PROTO_IP (0x800)
1	Service Agent	HAP_PROTO_SETUP (1)
1	other	HAP_PROTO_NONE (0)

To convert WPS-to-host messages, the protocol ID field will be deleted, and the IL bit will be set by:

```
IL = (protocol_id was HAP_PROTO_IP) ? 0 : 1;
```

HAP_PROTO_IP (see Appendix C) will be used for IP "versions" 3 (GG protocol), 4 (IP), and 5 (ST).

The datagram message header fields TTL and PRI have been swapped in HAP version 0 compared to version 1. The conversion code swaps the contents of these two fields for hosts running version 0.

The stream message header field TTL in HAP version 0 was replaced by the PRE field in version 1. Since the only permitted value of TTL was 1, and it is a valid PRE value, no conversion is necessary.

In HAP version 0, messages between a host and the Service Agent were allowed to contain Internet Protocol headers. No hosts use that capability, so no provision will be made to accommodate IP headers in Setups between hosts and the Service Agent.

In version 0, the Restart Request control message contained a "reason for restart" field. That field was ignored in all current implementations and has been eliminated in version 1.

Current implementations expect the WPS to insert an "incarnation count" in bits 5-10 of the first word of both Restart Request and Restart Complete messages. This functionality has been replaced by the "SL" bit in the Restart Complete message in version 1. Compatibility code will be added if needed, but it is expected that none will be needed.

13. Appendix C -- HAP Protocol ID Assigned Numbers

This section lists the values of the PROTOCOL ID field. This part of the specification will be obsolete when a version of the Assigned Numbers RFC containing HAP protocol ID numbers is issued.

HAP adopts the Ether-type numbers in the 1500-65535 range. Protocol IDs 256-511 identify ISO protocols. Zero indicates the absence of a

higher level protocol header. Other protocol IDs are reserved for future assignment.

Protocol ID -----	Indicates -----
0	No higher level protocol
1	For Network Service Agent messages
2-255	Reserved
256-511	ISO protocol identifier + 256
512-1499	Reserved
1500-65535	Identical to Ether-type [10].

HAP PROTOCOL ID NUMBERS
Figure 42

REFERENCES

1. Falk, G., Groff, S., Koolish, R., and W. Milliken, "PSAT Technical Report", BBN Technical Report No. 4469, Chapter 4, May 1981.
2. Rees, T., Editor, "A Host Access Protocol Specification", BBN Laboratories, Inc., May 1987. (A revision of RFC 907 that was distributed to DARPA and the WBNET user community but not resubmitted as an RFC.)
3. Postel, J., Editor, "Internet Protocol - DARPA Internet Program Protocol Specification", RFC 791, USC/Information Sciences Institute, September 1981.
4. Topolcic, C., Editor, "Experimental Internet Stream Protocol, Version 2 (ST-II)", RFC 1190, Bolt Beranek and Newman, Inc., October 1990.
5. Edmond, W., Seo, K., Leib, M., and C. Topolcic, "The DARPA Wideband Network Dual Bus Protocol", Proceedings of ACM SIGCOMM '90, pages 79-89, September 24-27, 1990.
6. "Host/SATNET Protocol", Internet Engineering Note (IEN) 192, July 1981.
7. Evenchik, L., McNeill, D., Bressler, R., Owen, A., Rice, Jr., R., Trout, G., Pavey, C., Damer, R., Deckelman, F., and T. Hughes, "MATNET, An Experimental Navy Shipboard Satellite Communications Network", Proceedings of INFOCOM '82, pages 3-11, March 30 - April 1, 1982.

8. Falk, G., Groff, J., Milliken, W., Nodine, M., Blumenthal, S., and W. Edmond, "Integration of Voice and Data in the Wideband Packet Satellite Network", IEEE Journal on Selected Areas in Communications, Vol. SAC-1, No. 6, December 1983.
9. "Interface Message Processor: Specifications for the Interconnection of a Host and an IMP", BBN Technical Report No. 1822, October 1980.
10. Reynolds, J., and J. Postel, "Assigned Numbers", RFC 1060, USC/Information Sciences Institute, March 1990.

Security Considerations

Security issues are not discussed in this memo.

Author's Address

Winston Edmond
Bolt Beranek and Newman, Inc.
Network Technologies Department
10 Moulton Street
Cambridge, Massachusetts 02138

Phone: (617) 873-3000

EMail: wbe@bbn.com

